



1510 - B Third Street
Tillamook, Oregon 97141
www.tillamookcounty.gov
503-842-3408

Land of Cheese, Trees and Ocean Breeze

**CONDITIONAL USE REQUEST #851-24-000397-PLNG
OREGON DEPT. OF FORESTRY/VERIZON WIRELESS
COMMUNICATION FACILITY**

*NOTICE TO MORTGAGEE, LIENHOLDER, VENDOR OR SELLER:
ORS 215 REQUIRES THAT IF YOU RECEIVE THIS NOTICE,
IT MUST BE PROMPTLY FORWARDED TO THE PURCHASER*

October 14, 2024

Dear Property Owner:

This is to confirm that the Tillamook County Department of Community Development **APPROVED WITH CONDITIONS** the above-cited request on October 14, 2024. A copy of the application, along with a map of the request area and the applicable criteria for review are available for inspection on the Tillamook County Department of Community Development website: <https://www.tillamookcounty.gov/commdev/landuseapps> and is also available for inspection at the Department of Community Development office located at 1510-B Third Street, Tillamook, Oregon 97141.

Appeal of this decision. This decision may be appealed to the Tillamook County Planning Commission, who will hold a public hearing. Forms and fees must be filed in the office of this Department before **4:00pm on October 28, 2024**. This decision will become final on October 28, 2024, after 4:00pm unless an appeal is filed in accordance with Tillamook County Land Use Ordinance Article X.

- Request:** Installation of a new wireless communications facility.
- Location:** Subject property is located off Wilson River Highway (6), a State highway, northeast of the Unincorporated Community of Siskeyville and designated as Tax Lot 200 in Section 1 of Township 1 South, Range 8 West of the Willamette Meridian, Tillamook County, Oregon.
- Zone:** Forest (F)
- Applicant:** Tessie Murakami, 5200 SW Meadows Road, Suite 150, Lake Oswego, OR 97035
- Property Owner:** Oregon Department of Forestry, 5005 3rd Street, Tillamook, OR 97141

CONDITIONS OF APPROVAL

TCLUO Sections 6.070: COMPLIANCE WITH CONDITIONS, and 6.080: TIME LIMIT requires compliance with approved plans and conditions of this decision, and all other ordinance provisions. Failure to comply with the Conditions of Approval and ordinance provisions could result in nullification of this approval.

1. Applicant/Owner shall obtain all required Federal, State, and Local permits and comply with all applicable Federal, State, and Local regulations, including but not limited to any requirements set forth by the Oregon Department of Aviation and Federal Aviation Administration and Oregon Department of Transportation.
2. Applicant/Owner shall obtain an approved Consolidated Zoning/Building Permit from the Tillamook County Department of Community Development for development of the new wireless communications facility.
3. The applicant and property owner shall adhere to applicable development standards in TCLUO Section 3.004: Forest (F) Zone.
 - (a) A site plan, drawn to scale, illustrating the proposed setbacks and fire breaks shall be provided at the time of Consolidated Zoning/Building Permit application submittal. The wireless communication tower shall maintain the required 30-foot setbacks from property lines as required under TCLUO Section 3.004.
 - (b) Applicant/Owner shall maintain the primary fuel-free break area surrounding all structures in accordance with the provisions in "Recommended Fire Siting Standards for Dwellings and Structures and Fire Safety Design Standards for Roads" dated March 1, 1991, and published by the Oregon Department of Forestry, contained in 'Exhibit D'. Fuel-free breaks shall also be depicted on the submitted site plan at the time of Consolidated Zoning/Building Permit application submittal.
4. Development shall comply with the applicable standards and requirements of TCLUO Section 4.130: Development Requirements for Geologic Hazard Areas. A Geologic Hazard Assessment is required if the average slope of the footprint or area to be disturbed is 29 percent or greater, measured from the highest to lowest point within the footprint or area to be disturbed. This measurement is taken from existing/pre-construction grade, prior to any cuts or fills.
5. A letter from the Oregon Department of Forestry indicating they will provide fire control service to the site will be required at the time of Consolidated Zoning/Building Permit application submittal.
6. Applicant/Owner shall provide evidence of a long-term road access agreement with the landowner of the subject property at the time of Consolidated Zoning/Building Permit application submittal.
7. Applicant/Owner shall provide a copy of the Oregon Department of Transportation Road Approach Permit for the subject property at the time of Consolidated Zoning/Building Permit application submittal.
8. In accepting this Approval, the Applicant/Owner understands intensive farm or forest practices may be conducted upon adjacent or nearby land zoned for farm or forest use. Applicant/Owner hereby acknowledges that practices may involve but are not limited to the application of herbicides or

fertilizers (including aerial spraying), road construction, changes in view, noise, dust, odor, traffic, and other impacts related to a farm zone. Applicant/Owner acknowledges use of this property may be impacted by such activities and is accepting of that fact. In the event of conflict, Applicant/Owner understands preference will be given to farm and forest practices.

A restrictive covenant acknowledging the above shall be recorded in the Tillamook County Clerk's Office prior to submittal of a zoning permit to this Department. A copy of the recorded covenant shall be submitted to the Department at the time of zoning permit application submittal.

9. This approval shall be void on October 14, 2026, unless construction of approved plans has begun, or an extension is requested from, and approved by this Department.

Sincerely,
Tillamook County Department of Community Development

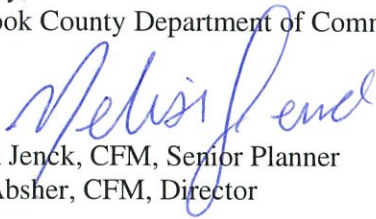

Melissa Jenck, CFM, Senior Planner
Sarah Absher, CFM, Director

Enc.: Vicinity, Assessor's and Zoning maps



Land of Cheese, Trees and Ocean Breeze

**CONDITIONAL USE REQUEST #851-24-000397-PLNG
OREGON DEPT. OF FORESTRY/VERIZON WIRELESS
WIRELESS COMMUNICATION FACILITY**

ADMINISTRATIVE DECISION & STAFF REPORT

Decision Date: October 14, 2024

**Decision: APPROVED WITH CONDITIONS
(This is not Building or Placement Permit Approval)**

Report Prepared by: Sarah Absher, CFM, Director & Melissa Jenck, CFM, Senior Planner

I. GENERAL INFORMATION:

- Request:** Installation of a new wireless communications facility (Exhibit B).
- Location:** Subject property is located off Wilson River Highway (6), a State highway, northeast of the Unincorporated Community of Siskeyville and designated as Tax Lot 200 in Section 1 of Township 1 South, Range 8 West of the Willamette Meridian, Tillamook County, Oregon (Exhibit A).
- Zone:** Forest (F)
- Applicant:** Tessie Murakami, 5200 SW Meadows Road, Suite 150, Lake Oswego, OR 97035
- Property Owner:** Oregon Department of Forestry, 5005 3rd Street, Tillamook, OR 97141

II. Property Description: The subject property encompasses approximately 4.84-acres of forested landscape and rugged terrain (Exhibit A). County records indicate the subject property is unimproved and is classified forest lands (Exhibit A).

Zoning in the area consists of Forest (F) zoned properties (Exhibit A). Aerial imagery confirms the forested areas within the vicinity are vacant of improvements and similar to the subject property, these forested areas consist of forested landscape and rugged terrain.

There are mapped wetlands features located in the vicinity and on the subject property, including the Wilson River and mapped creeks as depicted on the Oregon Statewide Wetlands Inventory Map (Exhibits A). These features are not located within close proximity to the proposed areas for development of a new wireless communications facility (Exhibits A & B). The subject property is located within Flood Zone D as depicted on FEMA FIRM 41057C0475F dated September 28, 2018, and is not within an Area of Special Flood Hazard (Exhibit A). The subject property is within a mapped area of known geologic hazard (Exhibit A). Identified hazards include rapidly moving landslides and shallow landslide susceptibility (Exhibit A).

III. APPLICABLE ORDINANCE AND COMPREHENSIVE PLAN PROVISIONS:

The desired use is governed through the following Sections of the Tillamook County Land Use Ordinance (TCLUO). The suitability of the proposed use, in light of these criteria, is discussed in Section IV of this report:

- A. TCLUO Section 3.004: Forest (F) Zone
- B. TCLUO Article VI: Conditional Use Procedures and Criteria

IV. ANALYSIS:

A. Section 3.004: Forest (F) Zone

PURPOSE: The purpose of the Forest (F) Zone is to protect and maintain forest lands for grazing, and rangeland use and forest use, consistent with existing and future needs for agricultural and forest products. The F zone is also intended to allow other uses that are compatible with agricultural and forest activities, to protect scenic resources and fish and wildlife habitat, and to maintain and improve the quality of air, water and land resources of the county.

1. **Section 3.004(13)** ‘Utility, Power Generation, Solid Waste Uses’ lists “*Television, microwave and radio communication facilities and transmission towers*” as Type 2 uses subject to conditional use review and approval.

Findings: Applicant is proposing the installation of a new wireless communications facility on the subject property (Exhibit B). The facility proposes to encompass a 10-foot by 10-foot ground leased area, that is to be located within a fenced area, accessed through the subject property via Wilson River Highway (OR State Highway 6) and an existing driveway on the subject property (Exhibit B). Improvements within the facility area include the following:

- 50-foot monopole tower with up to 3 antennas at an antenna tip-height of 50-feet
 - Monopole tower will be a metal pole and can be painted a non-reflective color to blend with adjacent mature trees and sky.
- Associated RRU’s
- Equipment cabinets
- Backup generator
- High security fence with 3 strands barbed wire

Applicant adds that the proposed monopole is part of Verizon’s small cells project in Tillamook County, requiring the need for additional poles to be installed along Wilson River Highway (OR State Highway 6) to provide adequate service coverage in the area (Exhibit B). Development of the proposed new wireless communication facility is subject to the Forest Zone Conditional Use Review Criteria found in TCLUO

Section 3.004(8) and the Conditional Use Review Criteria contained in TCLUO Article 6. Conditional Use review and approval is required for the project.

An accompanying site plan and facility improvement drawings are included in the Applicants submittal (Exhibit B). The proposed location for the facility is within close proximity to Wilson River Highway right-of-way (Exhibit B). The proposed location of the facility does not impede access to the forested areas of the subject property, minimizing potential impacts to surrounding forest operations (Exhibits A & B). Applicant adds that no additional forest land is needed for access or facility improvements (Exhibit B).

2. **Section 3.004(8): Conditional Use Review Criteria:** *A use authorized as a conditional use under this zone may be allowed provided the following requirements or their equivalent are met. These requirements are designed to make the use compatible with forest operations and agriculture and to conserve values found on forest lands. Conditional uses are also subject to Article 6, Section 040.*

1. *The proposed use will not force a significant change in, or significantly increase the cost of, accepted farming or forest practices on agriculture or forest lands.*

Findings: Applicant states that the area proposed for the installation of a new wireless communications facility as described above will encompass a 10-foot by 10-foot area, accessed via an existing driveway on the subject property (Exhibit B). Applicant states the facility has been designed to be consistent with applicable provisions of TCLUO Section 3.004 and Article 6 (Exhibit B).

Staff finds the proposed development will occupy a small portion of the subject property and will be located within close proximity of Wilson River Highway right-of-way. Given the proposed location for development of the facility, the small scale of development and the minimal area of the property to be utilized for the facility, staff finds that the proposed facility will not result in a significant change or increase in cost of accepted forest practices on forest lands are deemed. Staff finds that the proposed siting of a communication tower within this developed area will not significantly change or increase the cost of forest practices.

This criterion has been met.

2. *The proposed use will not significantly increase fire hazard or significantly increase fire suppression costs or significantly increase risks to fire suppression personnel.*

Findings: Applicant states the facility will be run on primary electric power provided by existing infrastructure at this location (Exhibit B). Applicant acknowledges measures must be taken to reduce risk of fire hazard and that development shall not increase fire suppression costs or significantly increase risks to fire suppression personnel (Exhibit B). The Oregon Department of Forestry (State of Oregon) is the landowner of the subject property (Exhibit B). Both the Oregon Department of Forestry and the US Forest Service were notified of this application, and did not provide comments.

This criterion has been met and can be met through Conditions of Approval.

3. *A written statement recorded with the deed or written contract with the county or its equivalent is obtained from the land owner that recognizes the rights of adjacent and nearby land owners to conduct forest operations consistent with the Forest Practices Act and Rules for uses authorized in OAR 660-006-0025(5)(c).*

Findings: Applicant also acknowledges and intends to provide the required written statement recognizing the rights of adjacent and nearby landowners to conduct forest operations consistency with Oregon Forest Practices act and Rules for uses authorized in OAR-660-006-0025(5)(c) (Exhibit B).

Staff finds that this criterion can be met through compliance with Conditions of Approval.

3. Section 3.004(9): Siting Standards for Dwelling or Structures in the Forest Zone:

(b) The minimum front, rear, and side yards shall all be 30 feet.

Findings: Applicant states the new wireless communications facility has been designed consistent with applicable provisions of this section as reflected in the drawings included in "Exhibit B" of this report. There are no minimum height requirements for non-residential structures in the Forest (F) Zone.

Staff finds that these standards have been met and can be met through the Conditions of Approval.

(d) Dwellings and structures shall be sited on the parcel so that:

- 1. They have the least impact on nearby or adjoining forest or agricultural lands;*
- 2. The siting ensures that adverse impacts on forest operations and accepted farming practices on the tract will be minimized;*
- 3. The amount of forest lands used to site access roads, service corridors, the dwelling and structures is minimized; and*
- 4. The risks associated with wildfire are minimized.*

(e) Siting criteria satisfying Subsection (d) may include setbacks from adjoining properties, clustering near or among existing structures, siting close to existing roads and siting on that portion of the parcel least suited for growing trees.

Findings: Staff finds that these requirements have been met as stated above in response to TCLUO Section 3.004(8) and additional information contained in "Exhibit B".

(f) The applicant shall provide evidence to the governing body that the domestic water supply is from a source authorized in accordance with the Water Resources Department's administrative rules for the appropriation of ground water or surface water and not from a Class II stream as defined in the Forest Practices rules (OAR chapter 629).

Findings: Domestic water is not required for the new wireless communications facility (Exhibit B).

(g) As a condition of approval, if road access to the dwelling is by a road owned and maintained by a private party or by the Oregon Department of Forestry, the U.S. Bureau of Land Management, or the U.S. Forest Service, then the applicant shall provide proof of a long-term road access use permit or agreement. The road use permit may require the applicant to agree to accept responsibility for road maintenance.

Findings: Staff finds that as a Condition of Approval copies of a long-term road access agreement satisfying the above criterion can be required to be provided to this Department at the time Applicant applies for consolidated zoning/building permit approval. Staff finds that this requirement can be met through compliance with Conditions of Approval.

4. Section 3.004(10): Fire Siting Standards for Dwelling and Structures:

(c) The owners of the dwellings and structures shall maintain a primary fuel-free break area surrounding all structures and clear and maintain a secondary fuel-free break area on land surrounding the dwelling that is owned or controlled by the owner in accordance with the provisions in "Recommended Fire Siting Standards for Dwellings and Structures and Fire Safety Design Standards for Roads" dated March 1, 1991, and published by the Oregon Department of Forestry and shall demonstrate compliance with Table (10)(c)1

Findings: The project is within the fire protection service area of the Oregon Department of Forestry. The Oregon Department of Forestry (State of Oregon) is the landowner of the subject property (Exhibit B).

TCLUO Article 11 defines a Structure as “*Anything constructed or installed or portable, the use of which requires a location on a parcel of land*”. As a Condition of Approval, the Applicant shall maintain the required fuel-free fire break areas around structures located on the subject property in accordance with TCLUO Section 3.004(10)(c). Staff finds that this requirement can be met through compliance with the Conditions of Approval.

B. Article VI Conditional Use Procedures and Criteria

Article VI of the Tillamook County Land Use Ordinance contains the procedures and review criteria for processing a Conditional Use request. These criteria, along with Staff's findings and conclusions, are indicated below.

1. **Section 6.020 Procedure** requires public notice in accordance with TCLUO Section 10.070 which requires notification of the request to be mailed to landowners within 750 feet of the subject property, to allow at least 14 days for written comment, and requires staff to consider comments received in making the decision.

Findings: Notice of the request was mailed to property owners and agencies on September 10, 2024, including Oregon Department of Forestry, US Forest Service, and the Oregon Department of Transportation (ODOT). Comments were received from the Oregon Department of Fish and Wildlife (ODFW) and Oregon Department of Transportation (ODOT). ODFW commented that proposed development should maintain 50-ft setbacks from the Wilson River riparian area (Exhibit C). ODOT provided comments that access shall be mailed for existing approaches along Highway. ODOT details that easements from the towers to the edge of pavement of the highway are not supported and must be removed (Exhibit C).

Staff finds this requirement has been met and concerns relevant to the criteria outlined in TCLUO Section 6.040 are addressed later in this report.

2. Section 6.040 Review Criteria

- 1. The use is listed as a conditional use in the underlying zone, or in an applicable overlying zone.*

Findings: Section 3.004(13) ‘Utility, Power Generation, Solid Waste Uses’ lists “*Television, microwave and radio communication facilities and transmission towers*” as Type 2 uses subject to conditional use review and approval.

Staff concludes that this criterion has been met.

- 2. The use is consistent with the applicable goals and policies of the comprehensive plan.*

Findings: Applicant states the new wireless communications facility will provide essential 911 emergency response wireless capabilities for first responders (Exhibit B). Applicant provides justification to support the proposed location of the facility meets applicable standards of TCLUO Section 4.008 and the criteria outlined in Subsection 8 (Exhibit B).

Applicable Comprehensive Plan Elements include the following:

- Tillamook County Comprehensive Plan Goal 4 Element: FOREST LANDS
Summary: This goal defines forest lands and requires counties to inventory them and adopt policies and

ordinances that will "conserve forest lands for forest uses."

- Tillamook County Comprehensive Plan Goal 11 Element: PUBLIC FACILITIES
Summary: Goal 11 calls for efficient planning of public services such as sewers, water, law enforcement, and fire protection. The goal's central concept is that public services should be planned in accordance with a community's needs and capacities rather than be forced to respond to development as it occurs. This Element of the Comprehensive Plan outline types and levels of urban and rural facilities and services, with guidance to ensure timely, orderly and efficient arrangement of public facilities and services in Tillamook County.
- Tillamook County Comprehensive Plan Goal 12 Element: TRANSPORTATION
Summary: The goal aims to provide "a safe, convenient and economic transportation system." It asks for communities to address the needs of the "transportation disadvantaged." Policies outlined in this Goal element of the Tillamook County Comprehensive Plan require the County to protect the function, operation and safety of existing and planned roadways as identified in the County's Transportation Plan, consider land use impacts on existing or planned transportation facilities in all land use decisions, plan for multi-modal networks, and coordinate transportation planning efforts with other jurisdictions to assure adequate connections to streets and transportation systems between incorporated and unincorporated areas.

Staff finds that the proposed use is permitted conditionally in the Tillamook County Land Use Ordinance. The TCLUO is an implementing document of the Comprehensive Plan. In the absence of evidence to the contrary, uses allowed conditionally in the Land Use Ordinance are presumed to be consistent with the Comprehensive Plan.

In terms of the specific goal elements summarized above, staff finds the proposed new wireless communications facility part of Verizon's small cells project in Tillamook County to provide adequate service coverage in the area is consistent with the policies contained within these elements. Demonstration by the Applicant that the project meets the criteria outlined in TCLUO Section 3.004(8) is previously addressed in this report. The proposed facility meets a growing need for public facilities and services within this area of Tillamook County and supports policies in the County's transportation element to address safety concerns of this existing transportation facility identified as Wilson River Highway (Oregon State Highway 6).

Staff concludes that this criterion has been met.

3. *The parcel is suitable for the proposed use considering its size, shape, location, topography, existence of improvements and natural features.*

Findings: As discussed above, the subject property encompasses approximately 4.84-acres of forested landscape and rugged terrain (Exhibit A). The subject property is improved with an existing driveway that will provide access to the new wireless communications facility (Exhibits A and B). As stated previously, the proposed location of the new wireless communications facility is within close proximity to Wilson River Highway right-of-way, minimizing potential impacts to surrounding forest operations (Exhibits A & B). Applicant adds that no additional forest land is needed for access or facility improvements (Exhibit B).

The proposed location of the new wireless communications facility is not within close proximity to any mapped creeks or the Wilson River (Exhibits A & B). Staff notified the Oregon Department of State Lands (DSL) of the proposal and no comments were received. Staff find that as a Condition of Approval, the applicant will be required to comply with all applicable state and federal regulations.

The subject property is within a mapped area of known geologic hazard and relevant standards of TCLUO Section 4.130: Development Requirements for Geologic Hazard Areas must be met at the time of permitting

and development (Exhibit A). Given the size of the property and slope at the location for siting the new wireless communications facility, staff finds a Geologic Hazard Assessment is not required as per the provisions outlined in TCLUO Section 4.130: Development Requirements for Geologic Hazard Areas; however, applicable development requirements contained in TCLUO Section 4.130 must be adhered to at the time of development.

Review of the site plan accompanying this application indicates the new wireless communications facility will be sited in a manner that complies with setback and fire siting standards for structures located within the Forest (F) Zone. Staff finds the communication tower will be sited in an area that does not encroach into surrounding areas dedicated to forest use (Exhibit B).

For the reasons stated above, staff find the proposed site is suitable for the proposed use considering its size, topography, absence of natural features in the area proposed for development and existing road access.

Staff concludes this criterion has been met.

4. *The proposed use will not alter the character of the surrounding area in a manner which substantially limits, impairs or prevents the use of surrounding properties for the permitted uses listed in the underlying zone.*

Findings: The character of the area consists of resource (forestry) use. Zoning in the area consists of Forest (F) (Exhibit A). Many Aerial imagery confirms the forested areas within the vicinity are vacant of improvements.

The 4.84-acre subject property borders only forest lands (Exhibit A). The proposed monopole tower will be 50-feet in height and applicant states the pole can be painted a non-reflective color to blend with the natural environment (Exhibit B). Applicant adds the proposed new wireless communications facility will be sited within close proximity to Wilson River Highway (OR State Highway 6) right of way, minimizing area of disturbance needed for the proposed facility improvement and minimizing impacts to surrounding forested areas (Exhibit B).

Staff finds that existing man-made and natural buffers such as the Wilson River Highway and heavily forested areas mitigate potential conflicts between the proposed new wireless communications facility and adjacent forestry uses in the vicinity. Staff find all improvements and activities necessary for maintenance and operation of the new wireless communications facility will take place within the property boundaries as described in this report and contained in "Exhibit B".

Staff finds that the proposed use will not substantially limit or impair surrounding forest uses nor increase fire hazard risk and will not alter the character of the surrounding area in a manner which substantially limits, impairs or prevents the use of surrounding properties for the permitted uses listed in the underlying zone.

Staff concludes this criterion has been met.

5. *The proposed use will not have a detrimental effect on existing solar energy systems, wind energy conversion systems or wind mills.*

Findings: The applicant states that there are no solar energy systems, wind energy conversion systems or wind mills in the area (Exhibit B). Tillamook County records confirm there are no such improvements within the vicinity.

Staff concludes that this criterion has been met.

6. *The proposed use is timely, considering the adequacy of public facilities and services existing or planned for the area affected by the use.*

Findings: Applicant states the proposed new wireless communications facility is intended to fill a significant gap in coverage and that Verizon Wireless has built a communication network to provide wireless services, including voice, data and enhanced 911 emergency services in the area (Exhibit B).

Staff finds there are existing public facilities and services in this area, including emergency response services and other services such as Tillamook People’s Utility District. Water and sanitation services are not required for the proposed new wireless communications facility.

The subject property and proposed new wireless communications facility is served by existing improved road systems, including Wilson River Highway (OR State Highway 6) and an existing private driveway on the subject property. The Oregon Department of Transportation (ODOT) was noticed of this request and did not provide comments during the comment period. As a Condition of Approval, a copy of the approved Road Approach Permit from ODOT for the subject property is required at the time of zoning permit application submittal.

Staff concludes that this criterion has been met.

IV. DECISION: APPROVED WITH CONDITIONS

Based on the findings shown above, Staff concludes that the applicant and property owner have satisfied the review criteria, and can meet all applicable ordinance requirements at the time of application. Therefore, the Department approves this request subject to the Conditions of Approval in section V of this report.

Appeal of this decision. This decision may be appealed to the Tillamook County Planning Commission, who will hold a public hearing. The forms and fees must be filed in the office of this Department before **4:00 PM on October 28, 2024.**

V. CONDITIONS OF APPROVAL:

Sections 6.070: COMPLIANCE WITH CONDITIONS, and 6.080: TIME LIMIT requires compliance with approved plans and conditions of this decision, and all other ordinance provisions. Failure to comply with the Conditions of Approval and ordinance provisions could result in nullification of this approval.

1. Applicant/Owner shall obtain all required Federal, State, and Local permits and comply with all applicable Federal, State, and Local regulations, including but not limited to any requirements set forth by the Oregon Department of Aviation and Federal Aviation Administration and Oregon Department of Transportation.
2. Applicant/Owner shall obtain an approved Consolidated Zoning/Building Permit from the Tillamook County Department of Community Development for development of the new wireless communications facility.
3. The applicant and property owner shall adhere to applicable development standards in TCLUO Section 3.004: Forest (F) Zone.
 - (a) A site plan, drawn to scale, illustrating the proposed setbacks and fire breaks shall be provided at the time of Consolidated Zoning/Building Permit application submittal. The wireless communication tower shall maintain the required 30-foot setbacks from property lines as required under TCLUO Section 3.004.

- (b) Applicant/Owner shall maintain the primary fuel-free break area surrounding all structures in accordance with the provisions in "Recommended Fire Siting Standards for Dwellings and Structures and Fire Safety Design Standards for Roads" dated March 1, 1991, and published by the Oregon Department of Forestry, contained in 'Exhibit D'. Fuel-free breaks shall also be depicted on the submitted site plan at the time of Consolidated Zoning/Building Permit application submittal.
4. Development shall comply with the applicable standards and requirements of TCLUO Section 4.130: Development Requirements for Geologic Hazard Areas. A Geologic Hazard Assessment is required if the average slope of the footprint or area to be disturbed is 29 percent or greater, measured from the highest to lowest point within the footprint or area to be disturbed. This measurement is taken from existing/pre-construction grade, prior to any cuts or fills.
 5. A letter from the Oregon Department of Forestry indicating they will provide fire control service to the site will be required at the time of Consolidated Zoning/Building Permit application submittal.
 6. Applicant/Owner shall provide evidence of a long-term road access agreement with the landowner of the subject property at the time of Consolidated Zoning/Building Permit application submittal.
 7. Applicant/Owner shall provide a copy of the Oregon Department of Transportation Road Approach Permit for the subject property at the time of Consolidated Zoning/Building Permit application submittal.
 8. In accepting this Approval, the Applicant/Owner understands intensive farm or forest practices may be conducted upon adjacent or nearby land zoned for farm or forest use. Applicant/Owner hereby acknowledges that practices may involve but are not limited to the application of herbicides or fertilizers (including aerial spraying), road construction, changes in view, noise, dust, odor, traffic, and other impacts related to a farm zone. Applicant/Owner acknowledges use of this property may be impacted by such activities and is accepting of that fact. In the event of conflict, Applicant/Owner understands preference will be given to farm and forest practices.

A restrictive covenant acknowledging the above shall be recorded in the Tillamook County Clerk's Office prior to submittal of a zoning permit to this Department. A copy of the recorded covenant shall be submitted to the Department at the time of zoning permit application submittal.

9. This approval shall be void on October 14, 2026, unless construction of approved plans has begun, or an extension is requested from, and approved by this Department.

VI. EXHIBITS

All Exhibits referred to herein are, by this reference, made a part hereof:

- A. Location map, Assessor map, Zoning map, Assessor's Summary Report, FEMA FIRM, State Wetland Inventory Map, Coastal Hazard Map
- B. Applicant's submittal
- C. Public Comments
- D. Recommended Fire Siting Standards for Dwellings and Structures and Fire Safety Design Standards for Roads published by Oregon Department of Forestry

EXHIBIT A

Vicinity Map

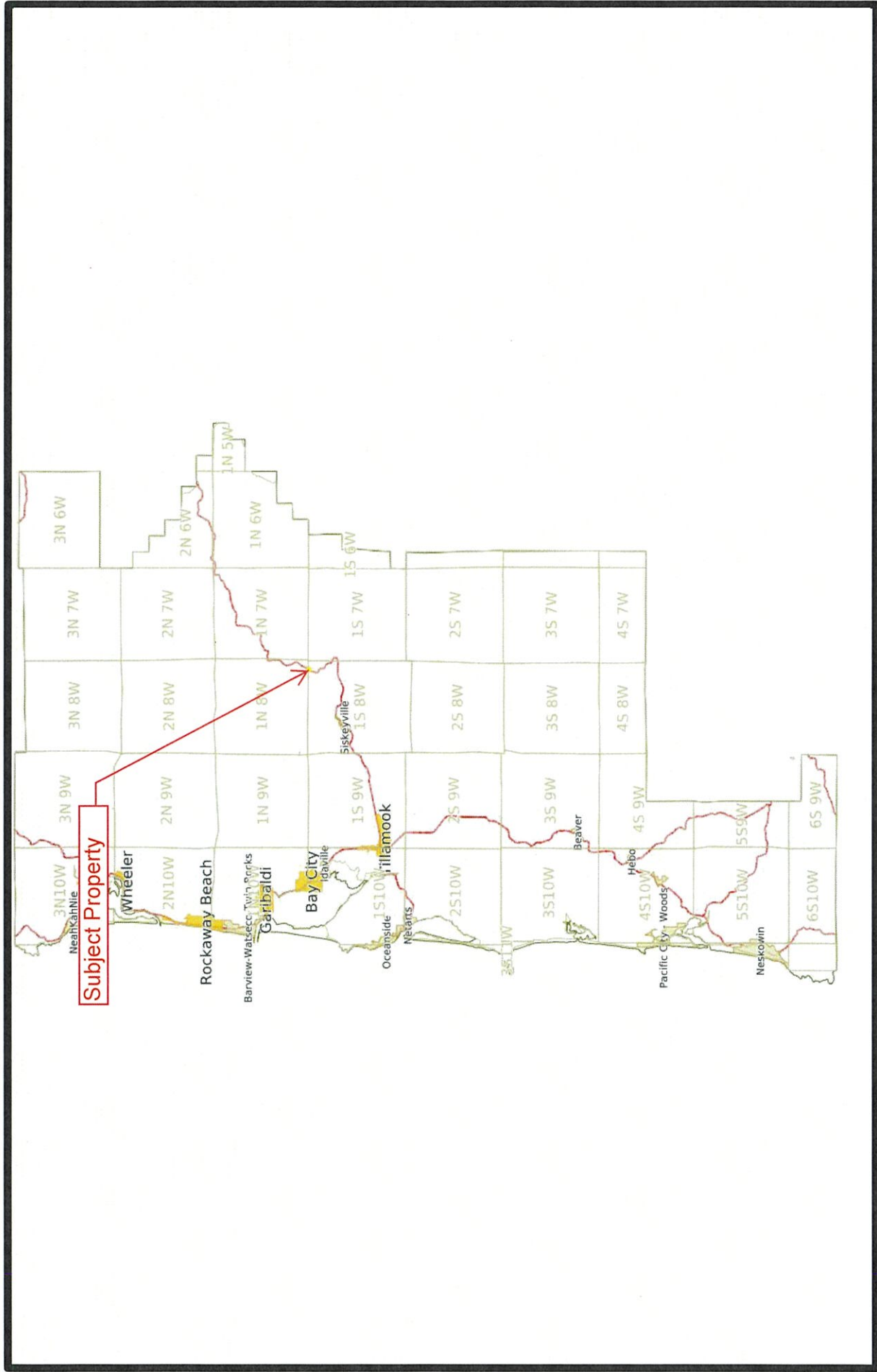

Zoning Map



FOR ASSESSMENT AND TAXATION ONLY. NOT SUITABLE FOR LEGAL, ENGINEERING, OR SURVEY PURPOSES

T.1S. R.8W. W.M.
Tillamook County

1" = 2000'

01S08W

01S08W

REVISED 05/22/16, WS

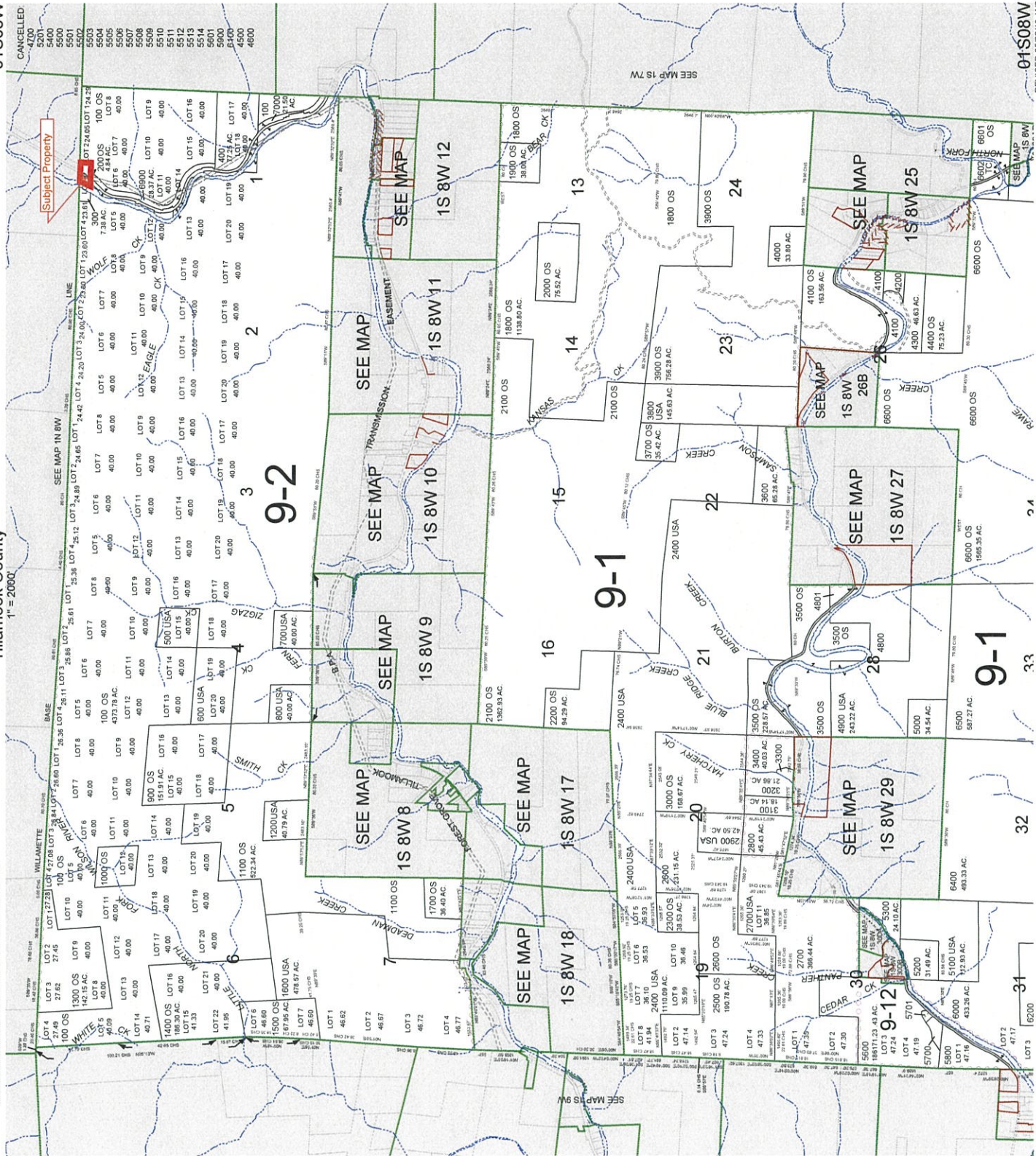

CANCELLED
4700
5201
5400
5500
5600
5700
5800
5900
6000
6100
6200
6300
6400
6500
6600
6700
6800
6900
7000
7100
7200
7300
7400
7500
7600
7700
7800
7900
8000
8100
8200
8300
8400
8500
8600
8700
8800
8900
9000
9100
9200
9300
9400
9500
9600
9700
9800
9900
10000

SEE MAP 15 7W
SEE MAP 15 8W
SEE MAP 15 9W
SEE MAP 15 10W
SEE MAP 15 11W
SEE MAP 15 12W
SEE MAP 15 13W
SEE MAP 15 14W
SEE MAP 15 15W
SEE MAP 15 16W
SEE MAP 15 17W
SEE MAP 15 18W
SEE MAP 15 19W
SEE MAP 15 20W
SEE MAP 15 21W
SEE MAP 15 22W
SEE MAP 15 23W
SEE MAP 15 24W
SEE MAP 15 25W
SEE MAP 15 26W
SEE MAP 15 27W
SEE MAP 15 28W
SEE MAP 15 29W
SEE MAP 15 30W
SEE MAP 15 31W
SEE MAP 15 32W
SEE MAP 15 33W
SEE MAP 15 34W
SEE MAP 15 35W
SEE MAP 15 36W
SEE MAP 15 37W
SEE MAP 15 38W
SEE MAP 15 39W
SEE MAP 15 40W

Tillamook County
2023 Real Property Assessment Report
 Account 299331

Map 1S08000000200
 Code - Tax ID 0902 - 299331

Tax Status Non-Assessable
 Account Status Active
 Subtype NORMAL

Legal Descr See Record

Mailing OREGON DEPARTMENT OF FORESTRY
 % STATE FORESTER, FOREST MANAGEMENT DIV
 2600 STATE ST
 SALEM OR 97310

Deed Reference # 2005-3944
 Sales Date/Price 04-18-2005 / \$0
 Appraiser UNKNOWN

Property Class 960 MA SA NH
 RMV Class 600 01 01 600

Site Situs Address	City
--------------------	------

Value Summary					
Code Area	RMV	MAV	AV	RMV Exception	CPR %
0902 Land	7,100		Land	0	
Impr	0		Impr	0	
Code Area Total	7,100	7,910	3,933	0	
Grand Total	7,100	7,910	3,933	0	

Land Breakdown									
Code Area	ID #	RFPD	Ex	Plan Zone	Value Source	Trend %	Size	Land Class	Trended RMV
0902	0	<input checked="" type="checkbox"/>		F	Classified Forest Land	100	4.84 AC	OA	7,100
Code Area Total							4.84 AC		7,100

Improvement Breakdown									
Code Area	Year Built	Stat Class	Description	Trend %	Total Sqft	Ex%	MS Acct	Trended RMV	

Exemptions / Special Assessments / Notations	
Code Area	Amount
0902	
Exemptions (AV)	
■ STATE GOVERNMENT 307.090	0

Comments 3/3/16 Size change per GIS.LM

National Flood Hazard Layer FIRMette

123°37'10"W 45°31'28"N



Legend

SEE FIS REPORT FOR DETAILED LEGEND AND INDEX MAP FOR FIRM PANEL LAYOUT

SPECIAL FLOOD HAZARD AREAS

- Without Base Flood Elevation (BFE)
Zone A, V, A99
- With BFE or Depth *Zone AE, AO, AH, VE, AR*
- Regulatory Floodway

OTHER AREAS OF FLOOD HAZARD

- 0.2% Annual Chance Flood Hazard, Area of 1% annual chance flood with average depth less than one foot or with drainage areas of less than one square mile *Zone >*
- Future Conditions 1% Annual Chance Flood Hazard *Zone X*
- Area with Reduced Flood Risk due to Levee. See Notes. *Zone X*
- Area with Flood Risk due to Levee *Zone D*

OTHER AREAS

- NO SCREEN
- Area of Minimal Flood Hazard *Zone X*
- Effective LOMRS
- Area of Undetermined Flood Hazard *Zone*
- Channel, Culvert, or Storm Sewer
- Levee, Dike, or Floodwall

OTHER FEATURES

- Cross Sections with 1% Annual Chance Water Surface Elevation
- Coastal Transect
- Base Flood Elevation Line (BFE)
- Limit of Study
- Jurisdiction Boundary
- Coastal Transect Baseline
- Profile Baseline
- Hydrographic Feature

MAP PANELS

- Digital Data Available
- No Digital Data Available
- Unmapped

The pin displayed on the map is an approximate point selected by the user and does not represent an authoritative property location.

This map complies with FEMA's standards for the use of digital flood maps if it is not void as described below. The basemap shown complies with FEMA's basemap accuracy standards

The flood hazard information is derived directly from the authoritative NFHL web services provided by FEMA. This map was exported on 10/13/2024 at 12:21 AM and does not reflect changes or amendments subsequent to this date and time. The NFHL and effective information may change or become superseded by new data over time.

This map image is void if the one or more of the following map elements do not appear: basemap imagery, flood zone labels, legend, scale bar, map creation date, community identifiers, FIRM panel number, and FIRM effective date. Map images for unmapped and unmodernized areas cannot be used for regulatory purposes.

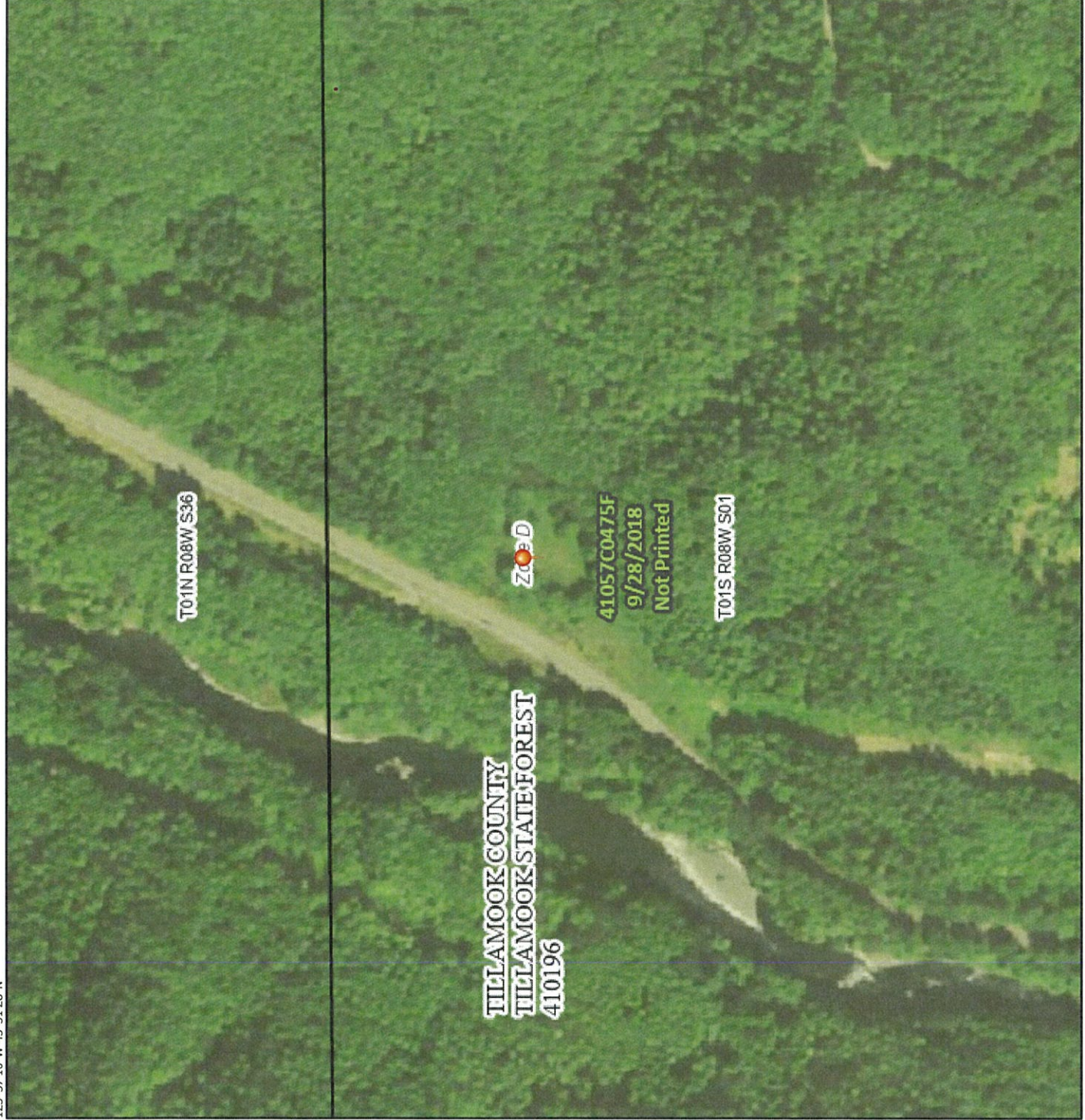

123°36'32"W 45°31'2"N

1:6,000

Feet



Hazard Map

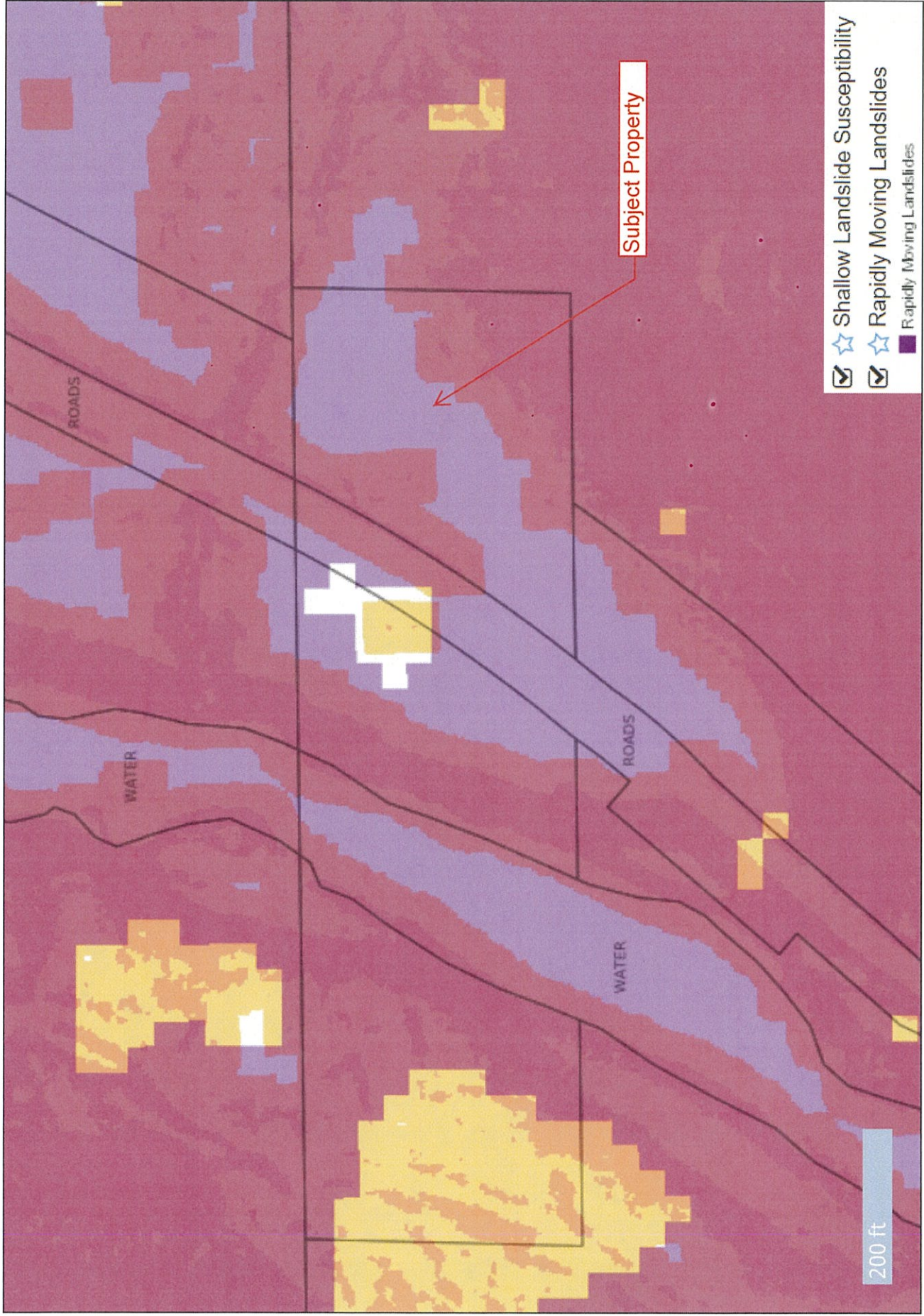

Disclaimer: The spatial information hosted at this website was derived from a variety of sources. Care was taken in the creation of these themes, but they are provided "as is". The state of Oregon, or any of the data providers cannot accept any responsibility for errors, omissions, or positional accuracy in the digital data or underlying records. There are no warranties, expressed or implied, including the warranty of merchantability or fitness for a particular purpose, accompanying any of these products. However, notification of any errors would be appreciated. The data are clearly not intended to indicate the authoritative location of property boundaries, the precise shape or contour of the earth or the precise location of fixed works of humans.

Statewide Wetlands Inventory

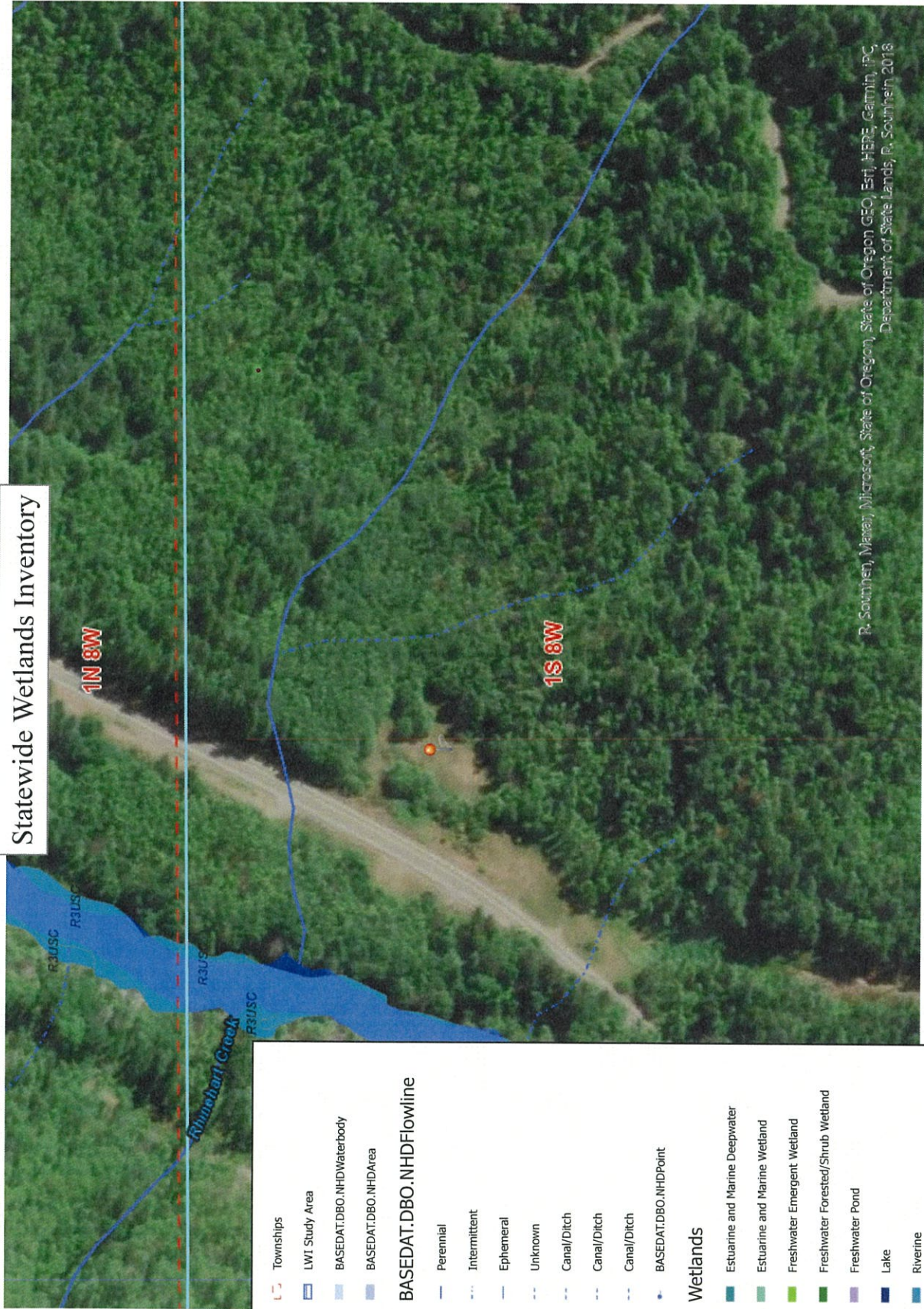

R. Sounness, Maxey, Microsoft, State of Oregon, State of Oregon GEO, Est. HERE, Garmin, IPC,
Department of State Lands, P. Sounness 2018

	Townships
	LWI Study Area
	BASEDAT.DBO.NHDWaterbody
	BASEDAT.DBO.NHDArea
BASEDAT.DBO.NHDFlowline	
	Perennial
	Intermittent
	Ephemeral
	Unknown
	Canal/Ditch
	Canal/Ditch
	Canal/Ditch
	BASEDAT.DBO.NHDPoint
Wetlands	
	Estuarine and Marine Deepwater
	Estuarine and Marine Wetland
	Freshwater Emergent Wetland
	Freshwater Forested/Shrub Wetland
	Freshwater Pond
	Lake
	Riverine
	SWI Agate-Winlo Soils
	SWI Predominantly Hydric Soil Map Units

1:4,514

0 0.03 0.06 0.11 0.17 0.22 0.28 mi

The Statewide Wetlands Inventory (SWI) represents the best data available at the time this map was published and is updated as new data becomes available. In all cases, actual field conditions determine the presence, absence, and type of wetlands and waters (such as creeks and ponds). An onsite investigation by a wetland professional can verify actual field conditions.



EXHIBIT B



PLANNING APPLICATION

OFFICE USE ONLY	
Date Stamp	RECEIVED JUL 05 2024 BY:
<input type="checkbox"/> Approved	<input type="checkbox"/> Denied
Received by:	
Receipt #: 138596	
Fees: 265	
Permit No: 851-21-00397 PLNG	

Applicant (Check Box if Same as Property Owner)
 Name: Tessie Murakami Phone: 310.483.5343
 Address: 5200 SW Meadows Rd., Suite 150
 City: Lake Oswego State: OR Zip: 97035
 Email: tessie.murakami@acomconsultinginc.com

Property Owner
 Name: State of Oregon, ODF Phone: 503-842-2545
 Address: 5005 3rd Street
 City: Tillamook State: OR Zip: 97141
 Email: kate.j.skinner@odf.oregon.gov

Request: Type II Conditional Use Review for a new wireless communications facility (with Verizon Wireless antennas collocated on light pole) along Highway 6.

Type II <input type="checkbox"/> Farm/Forest Review <input checked="" type="checkbox"/> Conditional Use Review <input type="checkbox"/> Variance <input type="checkbox"/> Exception to Resource or Riparian Setback <input type="checkbox"/> Nonconforming Review (Major or Minor) <input type="checkbox"/> Development Permit Review for Estuary Development <input type="checkbox"/> Non-farm dwelling in Farm Zone <input type="checkbox"/> Foredune Grading Permit Review <input type="checkbox"/> Neskowin Coastal Hazards Area	Type III <input type="checkbox"/> Detailed Hazard Report <input type="checkbox"/> Conditional Use (As deemed by Director) <input type="checkbox"/> Ordinance Amendment <input type="checkbox"/> Map Amendment <input type="checkbox"/> Goal Exception <input type="checkbox"/> Nonconforming Review (As deemed by Director) <input type="checkbox"/> Variance (As deemed by Director)	Type IV <input type="checkbox"/> Ordinance Amendment <input type="checkbox"/> Large-Scale Zoning Map Amendment <input type="checkbox"/> Plan and/or Code Text Amendment
--	---	---

Location:
 Site Address: No Address Wilson River Hwy., Tillamook, OR 97141 (299331/1S08000000200)
 Map Number: 1S _____ 08 _____ 00 _____ 0200
Township Range Section Tax Lot(s)

Clerk's Instrument #: _____

Authorization

This permit application does not assure permit approval. The applicant and/or property owner shall be responsible for obtaining any other necessary federal, state, and local permits. The applicant verifies that the information submitted is complete, accurate, and consistent with other information submitted with this application.

Property Owner Signature (Required)
Kate J. Skinner Digitally signed by Kate J. Skinner Date: 2024.06.24 11:46:14 -07'00' Date

Applicant Signature
 Tessie Murakami Date 7/2/24

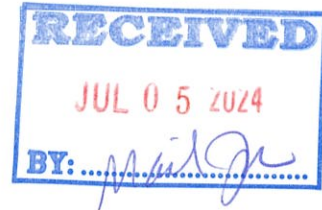

July 1, 2024

**Tillamook County Department of Community Development
1510-B Third Street
Tillamook, OR 97141**

RE: Wireless Facility Application
Site location: **no situs, Tillamook, OR 97141**
Site Name: **POR HWY 6 SC 6 (Acct 299331/Map Tax Lot 1S08000000200)**

Dear Tillamook County Planning Dept,

On behalf of Verizon Wireless, I am submitting the following information to seek approval for a new Wireless Communications Facility.

Please find enclosed the following land use information:

- Conditional Use Permit Application - Type II
- 3 copies of narrative, site plans, and other submittal items.

A separate check will be mailed out in the amount of \$2,625 for the zoning fees.

Please contact me for any questions at (310) 483-5343 or at tessie.murakami@acomconsultinginc.com

Sincerely,
Tessie Murakami

Tessie Murakami
Real Estate Contractor for Verizon Wireless



July 1, 2024

Tillamook County Department of Community Development
1510-B Third Street
Tillamook, OR 97141

**RE: Wireless Facility Application - Conditional Use Type II (POR HWY 6 SC 6)
at no situs, Tillamook, OR 97141 - Acct 299331/Map Tax Lot 1S08000000200**

To Whom It May Concern:

Please find enclosed a check in the amount of **\$2,625** for the land use fees relating to the land use submittal package.

Please contact me should you have any questions.

Best Regards,

Tessie Murakami

Tessie Murakami

Real Estate Contractor for Verizon Wireless
Phone 310-483-5343
Email tessie.murakami@acomconsultinginc.com

LAND USE APPLICATION -
NARRATIVE & STATEMENT
OF CODE COMPLIANCE

**VERIZON WIRELESS
TELECOMMUNICATIONS
FACILITY AT**

No Situs
Tillamook, OR 97141
(Acct 299331/Map lot
1S08000000200)

Prepared By



Date

January 19, 2018

Project Name

POR HWY 6 SC 6



I. GENERAL INFORMATION

Applicant: Verizon Wireless
5430 NE 122nd Avenue
Portland, OR 97230

Representative: Acom Consulting, Inc.
Tessie Murakami
5200 SW Meadows Rd., Suite 150
Lake Oswego, OR 97035

Property Owner: Oregon Dept. of Forestry
Kate J. Skinner
5005 3rd Street
Tillamook, OR 9141

Project Information:

Site Address: No Situs, Tillamook, OR 97141
Parcel: 1S08000000200
Account Number: 299331
Parcel Area: 4.84 acres
Zone Designation: F (Forest)
Existing Use: Forest
Project Area: 100 Square Feet (10' x 10') accessed by a short 10' wide access and utility easement.

II. PROJECT OVERVIEW

Acom Consulting is applying on behalf of Verizon Wireless, who will own and operate the tower and ground space; Cellco Partnership dba Verizon Wireless, who will be located on this facility and the property owner, Tillamook County. The site proposed herein is designed to improve the voice and data capacity for its customers in Tillamook County and along Highway 6. This is part of the initiative to provide better coverage of 911 calls on the highway since it is known as the deadly stretches in Oregon. The state is mandating all carriers to address the coverage gap at HWY OR-6.

The applicant proposes to construct a new wireless communications facility ("WCF") within a 10' x 10' ground lease area. This proposal includes a 50-foot monopole tower with up to 3 antennas at an antenna tip-height of 50' and associated RRU's, equipment cabinets, backup generator, and high security fence with 3 strands barbed wire. The site will be accessed via an existing driveway off HWY OR-6.

The monopole tower would be a metal pole and can be painted a non-reflective color to blend with the adjacent mature trees and sky. The proposed monopole (small cell) is only 50' and is a part of Verizon's small cells



project in Tillamook County which is requiring additional poles to be installed along HWY OR-6 for the proposal to provide adequate service coverage in the area.

This site was chosen because HWY OR-6 is currently significantly underserved by wireless coverage, even though there is a substantial amount of traffic every day. The lack of existing wireless facilities in the area contributes to lack of coverage. The newly proposed small cells will provide much needed coverage in areas that would be difficult to serve using conventional tower-based transmitters. These sites will not only help improve customer experience but also help public safety and emergency services by allowing communication in an otherwise cut-off area.

On August 8, 1996, the Federal Communications Commission adopted the first collocation rules designed to implement section 251(c)(6) of the Communications Act of 1934, as amended, ("the Act"), 47 U.S.C. § 251(c)(6). Section 251(c)(6) of the Act obligates carriers to provide, "on rates, terms, and conditions that are just, reasonable, and nondiscriminatory, for physical collocation of equipment necessary for interconnection or access to unbundled network elements." As such, Verizon will allow timely collocation by other users provided all structural, technological, and monetary requirements are satisfactory. Note any future collocation will require pole replacement for structural and RF purposes.

Additionally, this facility is passive use and will produce no odors, glare, vibration, or fumes. The applicant has mitigated the potential visual impact of the facility by proposing the minimum height necessary to meet coverage objectives and utilizing a design that is fitting of the surrounding environment. Public utilities are sufficient for this use. The site proposed herein is an unmanned facility that requires only power and telephone services. It does not require sewer or surface water drainage. Exterior lighting is not proposed.

The proposed facility would not interfere with surrounding properties or their uses, nor create any significant risk to public health and safety, flood hazard or emergency response, and will not cause interference with any electronic equipment, such as telephones, televisions, or radios. Non-interference is ensured by the Federal Communications Commission (FCC) regulation of radio transmissions. The proposed project may improve emergency response because it would improve wireless communication for citizens making emergency calls.

The site will meet or exceed all FCC requirements for non-ionizing electromagnetic radiation (NIER) emissions and will comply with all standards as required for Wireless Telecommunications Sites as regulated by Federal, State and the local jurisdiction.

At the termination of the Land Lease Agreement with the property owner, the facility will be removed within 120-days of termination of the lease and restored to its original condition, reasonable wear and tear and casualty excepted.



This facility has been located and designed to minimize the visual impact on the immediate surroundings and throughout the community and minimize public inconvenience and disruption while providing a desirable feature—reliable wireless service. Wireless service is critical today, with many people relying on their wireless devices for everything from information gathering, financial transactions to primary home phone service.

This site can meet the Tillamook County criteria for siting of new wireless telecommunication facilities, including height, setbacks and design as demonstrated herein. As shown throughout this application, Verizon’s proposal is the least intrusive means of meeting coverage objectives. The applicants respectfully request that Tillamook County approve the facility as proposed.

III. PROPOSED PLAN

This request is for review of the Land Use Development of a new proposed wireless communications facility. The subject property consists of approximately 4.84 acres of forested landscape and rugged terrain with existing primary access over an unnamed road off HWY OR-6. The subject property is surrounded by Forest and highway traffic.

IV. SITE SELECTION

Verizon seeks to improve a significant deficiency in their coverage in Tillamook County. The proposed site location was chosen to improve the wireless service to the public while traveling along HWY OR-6.

The Applicants site wireless communication facilities at carefully selected locations. The need for service in this specific geographic area was determined by market demand, coverage requirements for a specific geographic area, and the need to provide continuous coverage from one site to another. Once the need for additional coverage was established, Verizon’s RF engineers performed a study to determine the approximate site location and antenna height required to provide service in the desired coverage area. Using a computer modeling program that accounts for the terrain within the service area and other variables, such as proposed antenna height, available radio frequencies and wireless equipment characteristics, the engineers identified a “search ring,” wherein a site could be located to fill the coverage gap.

For this project, a significant deficiency in coverage was determined to exist in the proposed area along HWY OR-6.

This determination was a result of a combination of customer complaints and service and preliminary design analysis. Terrain data within the service area is entered into a modeling program along with a series of variables, such as proposed antenna height, available radio frequencies and wireless equipment characteristics. Using this information, Verizon’s RF engineers identified an area of optimum location for and height of a new wireless communication facility antenna to maximize the coverage objective.

When this technical analysis was completed, a search area map and a description of other requirements were provided to Verizon’s site development specialists. To provide coverage in this area, it was necessary to locate a facility that would provide coverage to the necessary areas in need.



With this information in hand, Verizon ranked potential sites. When designing an existing or new area for coverage or capacity, Verizon will first attempt to utilize an existing tower or structure for collocation at the desired antenna height. If an existing tower or structure is not available or not attainable because of space constraints or unreliable structural design, Verizon will propose a new tower. In this instance, our real estate group, with the help of outside consultants, did several searches and concluded there are no existing cell towers nearby for collocation that meet the communication site objectives.

Coverage maps and the RF Engineering and Design justification are attached herein for reference.

Federal, state, and local laws will apply to this application.

In Tillamook County, a new telecommunications facility at this Forest (F) location may be permitted via a conditional use and subject to the criteria per a Type II Conditional Use Permit application with the Planning Commission Review.

Federal law, primarily found in the Telecommunications Act, acknowledges a local jurisdiction's zoning authority over proposed wireless facilities but limits the exercise of that authority in several important ways. First, a local government must approve an application for a wireless communications site if three conditions are met: (1) there is a significant gap in service (coverage and or capacity); (2) the carrier has shown that the manner in which it proposes to provide service in the significant gap is the least intrusive on the values that the community seeks to protect as allowed by applicable law; and (3) there are no potentially available and technologically feasible alternatives that are less intrusive on the goals that the community seeks to protect as allowed by applicable law. 47 U.S.C Section 332(c)(7)(A) and (B)(i)(II); and T-Mobile USA, Inc. v. City of Anacortes, 572 P.3d 987 (9th Cir. 2009).

In addition, under the Telecommunications Act, the local jurisdiction is prohibited from considering the environmental effects (including health effects) of the proposed site if the site operates in compliance with federal regulations. 47 U.S.C. Section 332(c)(7)(B)(iv). Verizon has included with this application a statement from Hatfield & Dawson Consulting Electrical Engineers demonstrating that the proposed facility will operate in accordance with the Federal Communications Commission's RF emissions regulations - a NIER report (Attachment 9). Therefore, this issue is preempted under federal law and any testimony, or documents introduced relating to the environmental or health effects of the proposed site should be disregarded in this proceeding.

Furthermore, the Telecommunications Act requires jurisdictions not to discriminate amongst carriers (applicants) in the placement of Wireless facilities. The Telecommunications Act provides wireless carriers with important procedural due process protections, including the requirement that "the regulation of the placement, construction, and modification of personal wireless service facilities by any State or local government shall not prohibit or have the effect of prohibiting the provision of personal wireless services. 47 U.S.C. § 332(c)(7)(B)(i)(II). That is if a significant gap in service is demonstrated (capacity and or coverage), a local jurisdiction cannot deny the new service facility.

Verizon, in this application via extensive evidence has demonstrated that there is a significant gap in coverage and capacity for customers in Tillamook County, Oregon, and that the proposed facility is designed to fill this service gap in this area. The County is required to defer to Verizon's coverage objectives. There are other similar style and height of wireless towers that have been approved and installed in Tillamook County, including one on the same parcel as the proposed development. To deny or substantially condition this application would be a clear discrimination between carriers per the Telecom Act and Federal Law and deny Verizon's ability to provide similar service compared to other



carriers.

The proposed facility will comply fully with all Federal Communications Commission (FCC) safety standards. The FCC developed those standards in consultation with numerous other agencies, including the Institute of Electrical and Electronics Engineers (IEEE), Environmental Protection Agency, the Food and Drug Administration, and the Occupational Safety and Health Administration. The standards were developed by expert scientists and engineers after extensive reviews of the scientific literature related to RF biological effects over decades of wireless usage. The FCC explains that its standards “incorporate prudent margins of safety.” It explains further that “radio frequency emissions from antennas used for cellular and PCS transmissions result in exposure levels on the ground that are typically thousands of times below safety limits.” The FCC provides information about the safety of RF emissions from cellular base stations on its website at: <http://www.fcc.gov/oet/rfsafety/rf-faqs.html>. Included in the application is Evaluation of Compliance with FCC Guidelines for Human Exposure to Radiofrequency Radiation report (Attachment 9) prepared by Hatfield & Dawson, Consulting Electrical Engineers that are qualified to prepare the exposure report in compliance with FCC guidelines. This report demonstrates that Verizon’s proposed facility will be no risk to human health for RF exposure and is in compliance with FCC requirements.

Once Verizon develops a new facility, they follow a comprehensive program to ensure that they remain in compliance with the FCC limits while in service, which will include actual tests to confirm these limits following the sites going into service.

Wireless Communication facilities have been designated by Homeland Security as critical infrastructure of the United States. During events such as natural disasters or acts of terrorism, cell reception has been critical for first responders and emergency personnel to have effective communications.

V. APPLICABLE ORDINANCE AND COMPREHENSIVE PLAN PROVISIONS

- A. TCLUO Section 3.004: Forest (F) Zone
- B. TCLUO Article VI: Conditional Use Procedures and Criteria

VI. ANALYSIS

TCLUO Section 3.004: Forest (F) Zone

(1) PURPOSE

(a) The purpose of the Forest (F) Zone is to protect and maintain forest lands for grazing, and rangeland use and forest use, consistent with existing and future needs for agricultural and forest products. The F zone is also intended to allow other uses that are compatible with agricultural and forest activities, to protect scenic resources and fish and wildlife habitat, and to maintain and improve the quality of air, water and land resources of the county.

(b) The F zone has been applied to lands designated as Forest in the Comprehensive Plan. The provisions of the F zone reflect the forest land policies of the Comprehensive Plan



as well as the requirements of ORS Chapter 215 and OAR 660-006. The minimum parcel size and other standards established by this zone are intended to promote commercial forest operations.

Applicant's response: The proposed WCF is located in the Forest (F) zone.

(2) DEFINITIONS

Words used in the present tense include the future; the singular number includes the plural; and the word "shall" is mandatory and not directory. Whenever the term "this ordinance" is used herewith, it shall be deemed to include all amendments thereto as may hereafter from time to time be adopted.

For the purpose of this zone, the following definitions apply:

(dd) UTILITY FACILITIES NECESSARY FOR PUBLIC SERVICE: Unless otherwise specified in this Article, any facility owned or operated by a public, private or cooperative company for the transmission, distribution or processing of its products or for the disposal of cooling water, waste or by-products, and including, major trunk, pipelines, dams & and other hydroelectric facilities, water towers, sewage lagoons, cell towers, electrical transmission facilities (except transmission towers over 200' in height) including substations not associated with a commercial power generating facilities and other similar facilities.

Applicant's response: The proposed WCF qualifies as a utility facility necessary for public service.

TCLUO Article VI: Conditional Use Procedures and Criteria

(8) CONDITIONAL USE REVIEW CRITERIA:

A use authorized as a conditional use under this zone may be allowed provided the following requirements or their equivalent are met. These requirements are designed to make the use compatible with forest operations and agriculture and to conserve values found on forest lands. Conditional uses are also subject to Article 6, Section 040.

1. The proposed use will not force a significant change in, or significantly increase the cost of, accepted farming or forest practices on agriculture or forest lands.

Applicant's response: The proposed WCF has been designed to be consistent with all applicable provisions of this section, including the development and design standards under Section 3.004 and Article 6. Please see Drawings included as an attachment.

2. The proposed use will not significantly increase fire hazard or significantly increase fire suppression costs or significantly increase risks to fire suppression personnel.



Applicant's response: This is an unmanned Wireless Communication Facility that will be run on primary electric power provided by the existing infrastructure at this location. Please see Drawings included as an attachment.

3. A written statement recorded with the deed or written contract with the county or its equivalent is obtained from the land owner that recognizes the rights of adjacent and nearby land owners to conduct forest operations consistent with the Forest Practices Act and Rules for uses authorized in OAR 660-006-0025(5)(c).

Applicant's response: The applicant acknowledges and intends to comply with these provisions and is agreeable to this being included as a condition of approval.

(9) SITING STANDARDS FOR DWELLINGS AND STRUCTURES IN FOREST ZONES

The following siting criteria or their equivalent shall apply to all new dwellings and structures in forest zones. These criteria are designed to make such uses compatible with forest operations, to minimize wildfire hazards and risks and to conserve values found on forest lands. The County shall consider the criteria in this section together with the requirements of Section (10) to identify the building site:

- (a) The minimum lot width and minimum lot depth shall be 100 feet.
- (b) The minimum front, rear, and side yards shall all be 30 feet.
- (c) The height of residential structures shall not exceed 35 feet.
- (d) Dwellings and structures shall be sited on the parcel so that:
 1. They have the least impact on nearby or adjoining forest or agricultural lands;

Applicant's response: The proposed WCF has been designed to be consistent with all applicable provisions of this section, including the development and design standards under Section 3.004 and Article 6. Please see Drawings included as an attachment.

2. The siting ensures that adverse impacts on forest operations and accepted farming practices on the tract will be minimized;

Applicant's response: The proposed WCF has been designed to be consistent with all applicable provisions of this section, including the development and design standards under Section 3.004 and Article 6. The proposed location will not force a significant change in the forest practices on the property. Additionally, the proposed location is accessible by an existing road which minimizes possible adverse impacts.

3. The amount of forest lands used to site access roads, service corridors, the dwelling and structures is minimized; and



Applicant's response: The proposed new WCF will only use a 10 ft. x 10 ft. lease area of forest land on 4.84 acres parcel. Additionally, the proposed location is accessible by an existing road so no additional forest land will be utilized to construct an access road. The proposed WCF has been designed to be consistent with all applicable provisions of this section, including the development and design standards under Section 3.004 and Article 6. Please see Drawings included as an attachment.

4. The risks associated with wildfire are minimized.

Applicant's response: The proposed WCF has been designed to be consistent with all applicable provisions of this section, including the development and design standards under Section 3.004 and Article VI. The proposed location will not force a significant change in the forest practices on the property. Please see Drawings included as an attachment.

- (e) Siting criteria satisfying Subsection (d) may include setbacks from adjoining properties, clustering near or among existing structures, siting close to existing roads and siting on that portion of the parcel least suited for growing trees.

Applicant's response: The proposed WCF is sited close to an existing road as there are no existing wireless structures in the proximity of the parcel.

- (f) The applicant shall provide evidence to the governing body that the domestic water supply is from a source authorized in accordance with the Water Resources Department's administrative rules for the appropriation of ground water or surface water and not from a Class II stream as defined in the Forest Practices rules (OAR chapter 629). For purposes of this section, evidence of a domestic water supply means:
 1. Verification from a water purveyor that the use described in the application will be served by the purveyor under the purveyor's rights to appropriate water;
 2. A water use permit issued by the Water Resources Department for the use described in the application; or
 3. Verification from the Water Resources Department that a water use permit is not required for the use described in the application. If the proposed water supply is from a well and is exempt from permitting requirements under ORS 537.545, the applicant shall submit the well constructor's report to the county upon completion of the well.

Applicant's response: Not applicable. The proposed WCF is an unmanned facility that will not be connected to a water source.

- (g) As a condition of approval, if road access to the dwelling is by a road owned and maintained by a private party or by the Oregon Department of Forestry, the U.S. Bureau of Land Management, or the U.S. Forest Service, then the applicant shall provide proof of a long-term road access use permit or agreement. The road use permit may require the applicant to agree to accept responsibility for road maintenance.



Applicant's response: The applicant has negotiated and signed a lease agreement with the property owner for access to and use of the proposed lease area. The applicant respectfully asks that the County approve this WCF application with the understanding that the formal lease and easement agreements will be secured prior to commencement of construction. The applicant will apply for any road use permits required for the WCF. Finally, the applicant agrees to this being a condition of approval.

- (h) Approval of a dwelling shall be subject to the following requirements:
1. Approval of a dwelling requires the owner of the tract to plant a sufficient number of trees on the tract to demonstrate that the tract is reasonably expected to meet Department of Forestry stocking requirements at the time specified in Department of Forestry administrative rules;
 2. The planning department shall notify the county assessor of the above condition at the time the dwelling is approved;
 3. If the lot or parcel is more than 10 acres the property owner shall submit a stocking survey report to the county assessor and the assessor will verify that the minimum stocking requirements have been met by the time required by Department of Forestry rules;
 4. Upon notification by the assessor the Department of Forestry will determine whether the tract meets minimum stocking requirements of the Forest Practices Act. If that department determines that the tract does not meet those requirements, that department will notify the owner and the assessor that the land is not being managed as forest land. The assessor will then remove the forest land designation pursuant to ORS 321.359 and impose the additional tax; and
 5. The county governing body or its designate shall require as a condition of approval of a single-family dwelling under ORS 215.213, 215.383 or 215.284 or otherwise in a farm or forest zone, that the landowner for the dwelling sign and record in the deed records for the county a document binding the landowner, and the landowner's successors in interest, prohibiting them from pursuing a claim for relief or cause of action alleging injury from farming or forest practices for which no action or claim is allowed under ORS 30.936 or 30.937.

Applicant's response: Not applicable.



(10) FIRE-SITING STANDARDS FOR DWELLINGS AND STRUCTURES:

The following fire-siting standards or their equivalent shall apply to all new dwelling or structures in a forest zone:

- (a) The dwelling shall be located upon a parcel within a fire protection district or shall be provided with residential fire protection by contract. If the dwelling is not within a fire protection district, the applicant shall provide evidence that the applicant has asked to be included within the nearest such district. If the governing body determines that inclusion within a fire protection district or contracting for residential fire protection is impracticable, the governing body may provide an alternative means for protecting the dwelling from fire hazards that shall comply with the following:
 - 1. The means selected may include a fire sprinkling system, onsite equipment and water storage or other methods that are reasonable, given the site conditions;
 - 2. If a water supply is required for fire protection, it shall be a swimming pool, pond, lake, or similar body of water that at all times contains at least 4,000 gallons or a stream that has a continuous year round flow of at least one cubic foot per second;
 - 3. The applicant shall provide verification from the Water Resources Department that any permits or registrations required for water diversion or storage have been obtained or that permits or registrations are not required for the use; and
 - 4. Road access shall be provided to within 15 feet of the water's edge for firefighting pumping units. The road access shall accommodate the turnaround of firefighting equipment during the fire season. Permanent signs shall be posted along the access route to indicate the location of the emergency water source.

Applicant's response: The proposed new structure is an unmanned wireless facility. The applicant will comply with all required applicable fire code requirements. Also, the applicant requests the County to determine that inclusion in a fire protection district or contracting for residential fire protection is impracticable and provide an alternative means for protecting the structure from fire hazards if such means are deemed necessary.

- (b) Road access to the dwelling shall meet road design standards described in OAR 660-006-0040.

Applicant's response: The proposed WCF has been designed to be consistent with all applicable provisions of this section, including the development and design standards under Section 3.004 and Article VI.

- (c) The owners of the dwellings and structures shall maintain a primary fuel-free break area surrounding all structures and clear and maintain a secondary fuel-free break area on land surrounding the dwelling that is owned or controlled by the owner in accordance with the provisions in "Recommended Fire Siting Standards for Dwellings and Structures and Fire Safety Design Standards for Roads" dated March 1, 1991, and published by the Oregon Department of Forestry and shall demonstrate compliance with Table (10)(c)1



Applicant's response: The proposed WCF has been designed to be consistent with all applicable provisions of this section and Article VI, including the fuel break requirements noted in this Code section. Please see Final Zoning Drawings included as an attachment.

ARTICLE VI

CONDITIONAL USE PROCEDURES AND CRITERIA

SECTION 6.010: PURPOSE

The purpose of a CONDITIONAL USE is to provide for uses that are not allowed by right in a certain zone because of potentially adverse impacts on uses permitted by right in that zone. Such uses may be made or deemed compatible through the review process contained in this Article, which subjects the proposed CONDITIONAL USE activity to specific requirements, criteria, and conditions. The location and operation of any CONDITIONAL USE listed in this Ordinance shall only be permitted according to the provisions of this Article.

SECTION 6.020: PROCEDURE

The following procedure shall be observed in submitting and acting on a CONDITIONAL USE request:

- (1) A request may be initiated for a CONDITIONAL USE, or the modification of an approved CONDITIONAL USE, by filing an application with the Department. The Department may require any information necessary for a complete understanding of the proposed use and its relationship to surrounding properties.

Applicant's response: The Applicant has submitted a Conditional Use application with supporting documents including a narrative and statement of Compliance for the proposed WCF.

- (2) The Director shall act administratively according to the procedure set forth in Article 10, or shall refer the application to the Commission for a public hearing and decision. The application shall be referred to the Commission if the director determines that the proposed use would have significant impacts that extend beyond the abutting properties, and that those impacts are not likely to be adequately addressed by response to public notice required by Section 10.070. If the Director elects to refer the application to the Commission, it shall be heard at the next available Commission hearing, unless the applicant requests otherwise.
- (3) No CONDITIONAL USE permit shall be invalidated because of failure to receive the notice provided for in Section 10.070.

SECTION 6.030: GENERAL REQUIREMENTS

A CONDITIONAL USE shall be authorized, pursuant to the procedures set forth in Section 6.020, if the applicant adequately demonstrates that the proposed use satisfies all relevant requirements of this Ordinance, including the review criteria contained in Section 6.040 or the Health Hardship provisions contained in Section 6.050, and the following general requirements:

- (1) A CONDITIONAL USE shall be subject to the standards of the zone in which it is located, except as those standards have been modified in authorizing the CONDITIONAL USE. The size of a lot to be used for a public utility facility may be reduced below the minimum required, provided that it will have no adverse effect upon adjacent uses.



Applicant's response: The proposed WCF is located in and subject to the Forest (F) standards zone. The zone standards are addressed in the narrative and the Statement of Code Compliance.

- (2) A CONDITIONAL USE may be enlarged or altered pursuant to the following:
 - (a) Major alterations of a CONDITIONAL USE, including changes to or deletion of any imposed conditions, shall be processed as a new CONDITIONAL USE application.
 - (b) Minor alterations of a CONDITIONAL USE may be approved by the Director according to the procedures used for authorizing a building permit, if such alterations are requested prior to the issuance of a building permit for the CONDITIONAL USE. Minor alterations are those which may affect the siting and dimensions of structural and other improvements relating to the CONDITIONAL USE, and may include small changes in the use itself. Any change which would affect the basic type, character, arrangement, or intent of the approved CONDITIONAL USE shall be considered a major alteration.
 - (c) The enlargement or alteration of a one-or two-family dwelling, mobile home, manufactured home, or recreational vehicle that is authorized as a CONDITIONAL USE under the provisions of this Ordinance shall not require further authorization, if all applicable standards and criteria are met.
- (3) Where the approval of a CONDITIONAL USE request is contingent upon an amendment to this Ordinance, and an application for such amendment has been recommended for approval by the Commission, the CONDITIONAL USE request may be approved upon the condition that the Board approves the Ordinance Amendment.

SECTION 6.040: REVIEW CRITERIA

Any CONDITIONAL USE authorized according to this Article shall be subject to the following criteria, where applicable:

- (1) The use is listed as a CONDITIONAL USE in the underlying zone, or in an applicable overlying zone.

Applicant's response: Per 3.004 (13) Use Table, television, microwave and radio communication facilities and transmission towers are permitted by a Type 2 CUP in the underlying Forest (F) zone (subject to 3.004(8) above). There is no applicable overlay zone for this location.

- (2) The use is consistent with the applicable goals and policies of the Comprehensive Plan.

Applicant's response: This is an unmanned cellular site that will provide essential 911 emergency response wireless capabilities to first responders. The site is located near an existing access road and will not directly impact the productivity of the ongoing forest operations on this land. Please see Drawings and RF Justification included as attachments.

- (3) The parcel is suitable for the proposed use considering its size, shape, location, topography, existence of improvements and natural features.



Applicant's response: As noted, the proposed WCF will be sited in close proximity of an existing access road. Also, the property owner (ODF) participated in selecting the site location that will not directly impact the productivity of the ongoing operations on this parcel. Please see Drawings included as an attachment.

- (4) The proposed use will not alter the character of the surrounding area in a manner which substantially limits, impairs or prevents the use of surrounding properties for the permitted uses listed in the underlying zone.

Applicant's response: As noted, the proposed WCF will be sited in close proximity of an existing access road. Also, the property owners participated in selecting the site location that will not directly impact the productivity of the ongoing forest operations on this parcel. Please see Drawings included as an attachment.

- (5) The proposed use will not have detrimental effect on existing solar energy systems, wind energy conversion systems or wind mills.

Applicant's response: Not applicable. There are no solar energy systems, wind energy conversion systems, or wind mills in this area.

- (6) The proposed use is timely, considering the adequacy of public facilities and services existing or planned for the area affected by the use.

Applicant's response: This proposed WCF is intended to fill a significant gap in coverage as shown in the attached RF Justification and maps. Verizon Wireless has built a communication network to provide wireless services, which include voice, data, and enhanced 911 emergency services in the area experiencing a significant gap in coverage along HWY OR-6 (Tillamook County). Verizon's objective for this site is to improve these wireless services, offload a nearby capacity site that is currently providing coverage in this area and fill in new areas that do not have a strong enough signal strength to hold a call or access their network. This proposed site is an essential WCF for public service as part of Verizon Wireless; communication network providing enhanced 911 services as well as serving many governmental agencies and emergency responders. HWY OR-6 is currently significantly underserved by wireless coverage, even though there is a substantial amount of traffic every day. To get the quality service experience for their customers and others that count on their network along HWY OR-6 (Tillamook County), Verizon will need this new 50 ft. tower to provide adequate coverage in this area.

TOWAIR Determination Results

*** NOTICE ***

TOWAIR's findings are not definitive or binding, and we cannot guarantee that the data in TOWAIR are fully current and accurate. In some instances, TOWAIR may yield results that differ from application of the criteria set out in 47 C.F.R. Section 17.7 and 14 C.F.R. Section 77.13. A positive finding by TOWAIR recommending notification should be given considerable weight. On the other hand, a finding by TOWAIR recommending either for or against notification is not conclusive. It is the responsibility of each ASR participant to exercise due diligence to determine if it must coordinate its structure with the FAA. TOWAIR is only one tool designed to assist ASR participants in exercising this due diligence, and further investigation may be necessary to determine if FAA coordination is appropriate.

DETERMINATION Results

Structure does not require registration. There are no airports within 8 kilometers (5 miles) of the coordinates you provided.

Your Specifications

NAD83 Coordinates

Latitude	45-29-33.7 north
Longitude	123-37-45.6 west

Measurements (Meters)

Overall Structure Height (AGL)	24.4
Support Structure Height (AGL)	NaN
Site Elevation (AMSL)	75.9

Structure Type

MTOWER - Monopole

Tower Construction Notifications

Notify Tribes and Historic Preservation Officers of your plans to build a tower.

CLOSE WINDOW

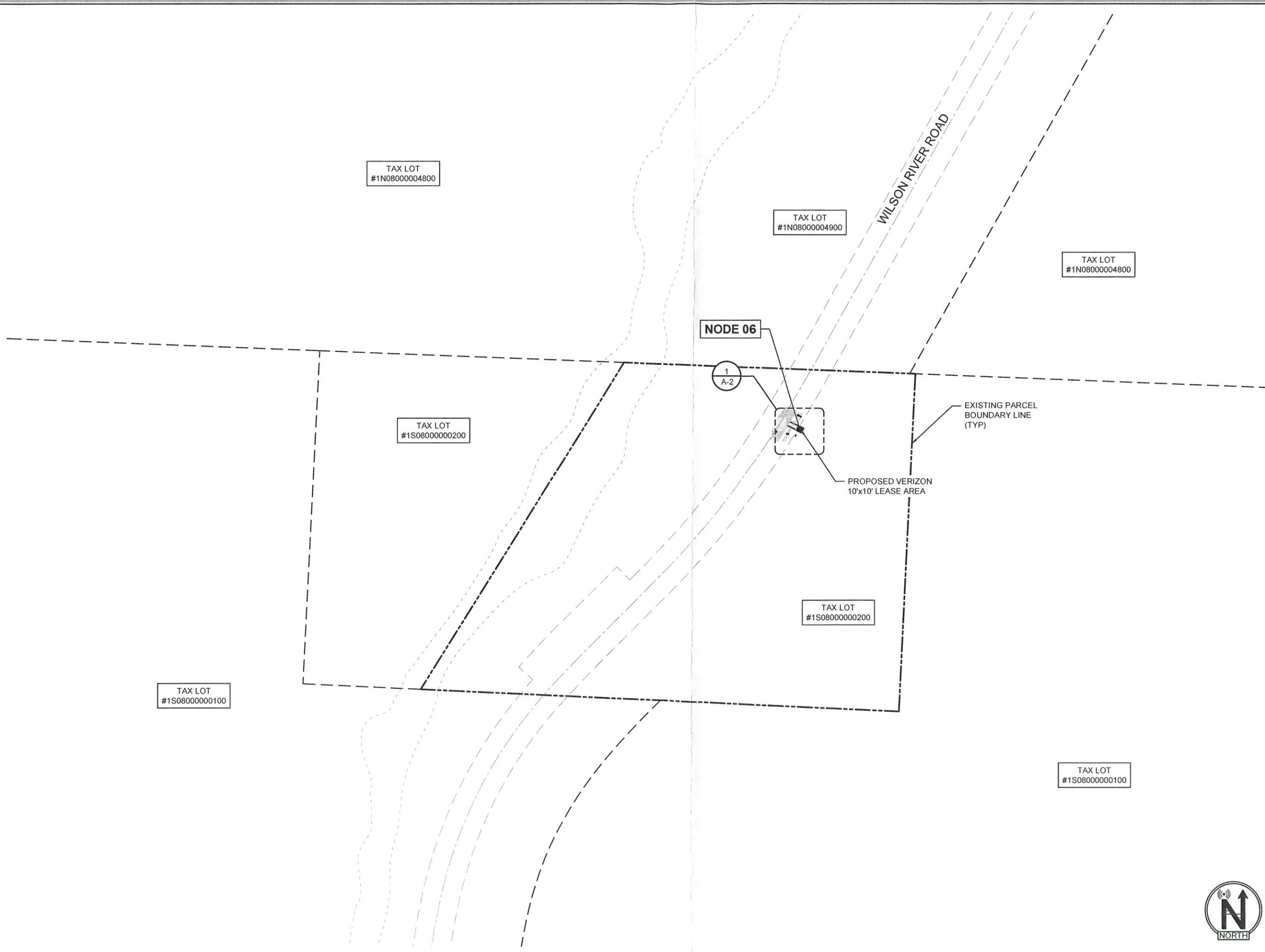

NO.	DATE	DRAWN	REVISION
A	05/19/23	KM	90% PCD REVIEW
B	08/03/23	KM	SURVEY UPDATE
C	06/04/24	KM	RFDS UPDATE

CLIENT:



A&E CONSULTANT, SITE ACQUISITION AND PERMITTING



**HWY 6
 SMALL CELL NODE 06**
 WILSON RIVER HWY
 TILLAMOOK, OR 97141

**OVERALL SITE
 PLAN**

A-1.0

22"x34" SCALE: 1" = 200'-0"
 11"x17" SCALE: 1" = 400'-0"



verizon

HWY 6

MDG LC: 5000908252

SITE NAME: POR HWY 6 - 06
 ADDRESS: WILSON RIVER HWY
 TILLAMOOK, OR 97141
 COUNTY: TILLAMOOK
 JURISDICTION: TILLAMOOK COUNTY
 POLE TYPE: NEW METAL POLE
 POLE #: NA
 ANTENNA LOCATION: POLE MOUNTED

VICINITY MAP

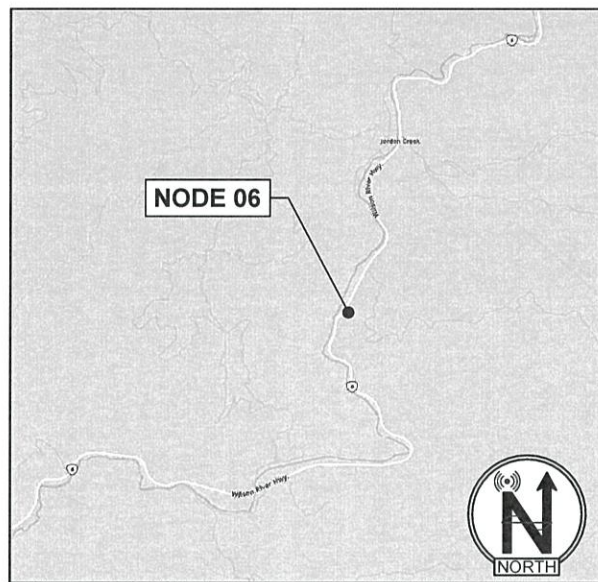

TOWER PHOTO

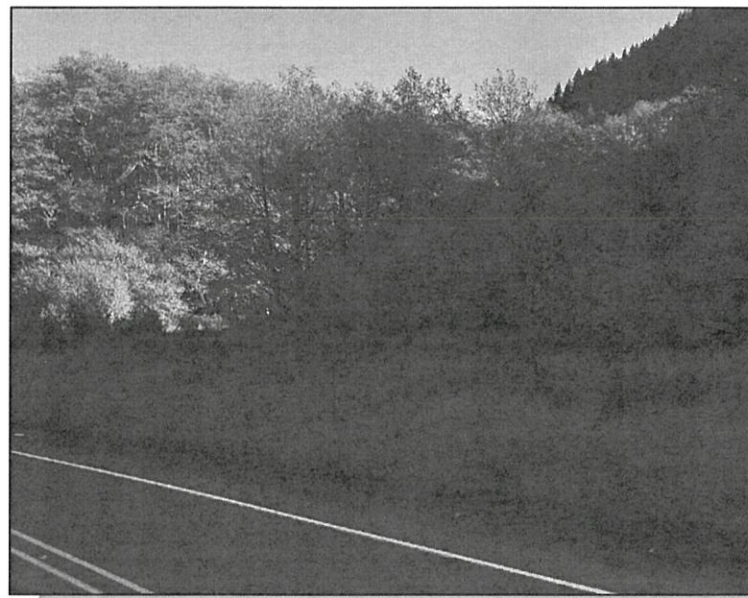

PROJECT CONTACT LIST

PROPERTY OWNER: OREGON DEPARTMENT OF FORESTRY
UTILITY TOWER OWNER: N/A
IMPLEMENTATION CONTACT: CHRISTOPHER LEWIS
 VERIZON WIRELESS (VAW) LLC (d/b/a VERIZON WIRELESS)
 5430 NE 122ND AVENUE
 PORTLAND, OR 97230
 PHONE: (951) 796-5523
 christopher.lewis2@verizonwireless.com
A&E CONSULTANT: RICK MATTESON
 ACOM CONSULTING, INC
 5200 SW MEADOWS RD
 SUITE 150
 LAKE OSWEGO, OR 97035
 PHONE: (425) 209-6723
 rick.matteson@acomconsultinginc.com
REAL ESTATE: SARAH BLANCHARD
 ACOM CONSULTING, INC
 5200 SW MEADOWS RD, SUITE 150
 LAKE OSWEGO, OR 97035
 PHONE : (503) 310-5538
 sarah.blanchard@acomconsultinginc.com
ZONING / PERMITTING: TESSIE MURAKAMI
 ACOM CONSULTING, INC
 5200 SW MEADOWS RD, SUITE 150
 LAKE OSWEGO, OR 97035
 PHONE : (310) 483-5343
 tessie.murakami@acomconsultinginc.com
ENGINEER OF RECORD: WELLS L. HOLMES, S.E.
 VECTOR STRUCTURAL ENGINEERING
 651 W GALENA PARK BLVD, SUITE 101
 DRAPER, UT 84020
 PHONE: (801) 990-1775
ELECTRICAL ENGINEER: DEAN P. LEVORSEN, P.E.
 VECTOR STRUCTURAL ENGINEERING
 651 W GALENA PARK BLVD, SUITE 101
 DRAPER, UT 84020
 PHONE: (801) 990-1775

DRAWING INDEX

T-1	COVER SHEET
T-2	GENERAL NOTES AND SYMBOLS
A-1.0	AERIAL IMAGE / SITE LOCATION
A-2.0	ANTENNA & EQUIPMENT PLANS
A-3.0	EXISTING AND PROPOSED ELEVATIONS
A-4.0	CONSTRUCTION DETAILS
A-5.0	CONSTRUCTION DETAILS
A-6.0	ANTENNA DETAILS
E-1.0	TYPICAL ONE-LINE DIAGRAM AND PANEL SCHEDULE
RF-1	ANTENNA CONFIGURATION
	TOWER SPECIFICATION SHEET (1 OF 4)
	TOWER SPECIFICATION SHEET (2 OF 4)
	TOWER SPECIFICATION SHEET (3 OF 4)
	TOWER SPECIFICATION SHEET (4 OF 4)

LOCATION MAP

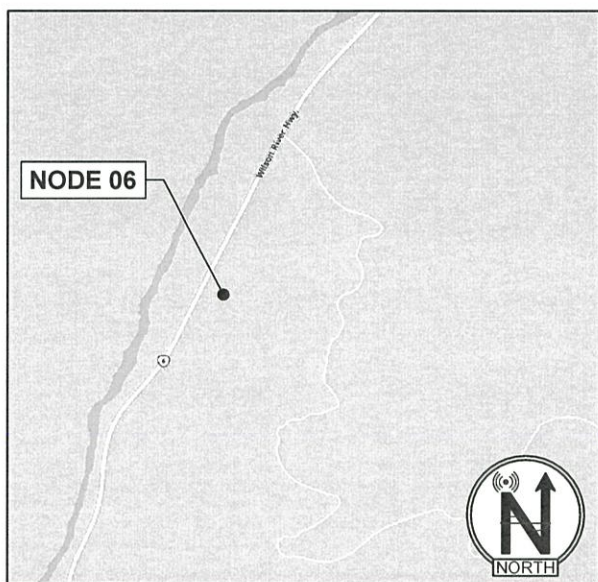

DRIVING DIRECTIONS

FROM VERIZON WIRELESS OFFICE - PORTLAND, OR:
 TBD

CODE COMPLIANCE

ALL WORK AND MATERIALS SHALL BE PERFORMED AND INSTALLED IN ACCORDANCE WITH THE CURRENT CONDITIONS OF THE FOLLOWING CODES AS ADOPTED BY THE LOCAL GOVERNING AUTHORITIES. NOTHING IN THESE PLANS IS TO BE CONSTRUED TO PERMIT WORK NOT CONFORMING TO THESE CODES:

OREGON STATE AND LOCAL BUILDING CODES WITH THE FOLLOWING REFERENCE CODE:
 2021 IBC, STANDARDS AND AMENDMENTS - 2022 OSSC
 2022 OREGON MECHANICAL SPECIALTY CODE (OMSC)
 2021 IFC, STANDARDS AND AMENDMENTS - 2022 OFC
 2021 UPC, STANDARDS AND AMENDMENTS - 2021 OPSC
 2020 NEC, STANDARDS AND AMENDMENTS - 2021 OESC

PROJECT INFORMATION

JURISDICTION: TILLAMOOK COUNTY
 ZONING CLASSIFICATION: F - FOREST
 ADJACENT ZONE: R-6
 CONSTRUCTION TYPE: UTILITY
 PROPOSED BUILDING USE: TELECOM
 PROPOSED STRUCTURE HEIGHT: 50.0' (TOP OF NEW POLE)
 LATITUDE: 45.520899° N
 45° 31' 15.24" N
 LONGITUDE: -123.614775° W
 123° 36' 53.19" W
 GROUND ELEVATION: ±344.4 AMSL

SCOPE OF WORK

VERIZON WIRELESS PROPOSES TO:
 • PROPOSES TO INSTALL WIRELESS EQUIPMENT IN FENCED COMPOUND LOCATED OUTSIDE R-O-W
 • PROPOSES TO INSTALL (4) NEW ANTENNAS & (1) NEW MOUNT ON NEW POLE
 • PROPOSES TO INSTALL (1) NEW SMALL CELL CABINET ON CONCRETE PAD
 • PROPOSES TO INSTALL (1) NEW HYBRID AND APPROVED CABLE STRAP MOUNTED ON NEW POLE

DO NOT SCALE DRAWINGS. CONTRACTOR MUST VERIFY ALL DIMENSIONS AND ADVISE CONSULTANTS OF ANY ERRORS OR OMISSIONS. NO VARIATIONS OR MODIFICATIONS TO WORK SHOWN SHALL BE IMPLEMENTED WITHOUT PRIOR WRITTEN APPROVAL. ALL PREVIOUS ISSUES OF THIS DRAWING ARE SUPERSEDED BY THE LATEST REVISION. ALL DRAWINGS AND SPECIFICATIONS REMAIN THE PROPERTY OF ACOM CONSULTING.

NO	DATE	DRAWN	REVISION
A	05/19/23	KM	90% PCD REVIEW
B	08/03/23	KM	SURVEY UPDATE
C	06/04/24	KM	RFDS UPDATE



**HWY 6
 SMALL CELL NODE 06**
 WILSON RIVER HWY
 TILLAMOOK, OR 97141

COVER SHEET

T-1

GENERAL NOTES

- WORK SHALL COMPLY WITH ALL APPLICABLE CODES, ORDINANCES, AND REGULATIONS. ALL NECESSARY LICENSES, CERTIFICATES, ETC., REQUIRED BY AUTHORITY HAVING JURISDICTION SHALL BE PROCURED AND PAID FOR BY THE CONTRACTOR.
- ACOM HAS NOT CONDUCTED, NOR DOES IT INTEND TO CONDUCT ANY INVESTIGATION AS TO THE PRESENCE OF HAZARDOUS MATERIAL, INCLUDING, BUT NOT LIMITED TO, ASBESTOS WITHIN THE CONFINES OF THIS PROJECT. ACOM DOES NOT ACCEPT RESPONSIBILITY FOR THE INDEMNIFICATION, THE REMOVAL, OR ANY EFFECTS FROM THE PRESENCE OF THESE MATERIALS. IF EVIDENCE OF HAZARDOUS MATERIALS IS FOUND, WORK IS TO BE SUSPENDED AND THE OWNER NOTIFIED. THE CONTRACTOR IS NOT TO PROCEED WITH FURTHER WORK UNTIL INSTRUCTED BY THE OWNER IN WRITING.
- ALL MATERIAL FURNISHED UNDER THIS CONTRACT SHALL BE PROPOSED, UNLESS OTHERWISE NOTED. ALL WORK SHALL BE GUARANTEED AGAINST DEFECTS IN MATERIALS AND WORKMANSHIP. THE CONTRACTOR SHALL REPAIR OR REPLACE AT HIS EXPENSE ALL WORK THAT MAY DEVELOP DEFECTS IN MATERIALS OR WORKMANSHIP WITHIN SAID PERIOD OF TIME OR FOR ONE YEAR AFTER THE FINAL ACCEPTANCE OF THE ENTIRE PROJECT, WHICHEVER IS GREATER.
- THE GENERAL CONTRACTOR AND EACH SUBCONTRACTOR SHALL BE RESPONSIBLE FOR VERIFYING ALL EXISTING CONDITIONS AND UTILITIES AT THE JOB SITE BEFORE WORK IS STARTED. NO CLAIMS FOR EXTRA COMPENSATION FOR WORK WHICH COULD HAVE BEEN FORESEEN BY AN INSPECTION, WHETHER SHOWN ON THE CONTRACT DOCUMENTS OR NOT, WILL BE ACCEPTED OR PAID.
- THE GENERAL CONTRACTOR AND EACH SUBCONTRACTOR SHALL BE RESPONSIBLE FOR VERIFYING DIMENSIONS AND CONDITIONS AT THE JOB SITE WHICH COULD AFFECT THE WORK UNDER THIS CONTRACT. ALL MANUFACTURERS RECOMMENDED SPECIFICATIONS, EXCEPT THOSE SPECIFICATIONS HEREIN, WHERE MOST STRINGENT SHALL BE COMPLIED WITH.
- THE CONTRACTOR SHALL VERIFY AND COORDINATE SIZE AND LOCATION OF ALL OPENINGS FOR STRUCTURAL, MECHANICAL, ELECTRICAL, PLUMBING, CIVIL, OR ARCHITECTURAL WORK.
- THE CONTRACTOR SHALL VERIFY THAT NO CONFLICTS EXIST BETWEEN THE LOCATIONS OF ANY AND ALL MECHANICAL, ELECTRICAL, PLUMBING, OR STRUCTURAL ELEMENTS, AND THAT ALL REQUIRED CLEARANCES FOR INSTALLATION AND MAINTENANCE ARE MET. NOTIFY THE CONSULTANT OF ANY CONFLICTS. THE CONSULTANT HAS THE RIGHT TO MAKE MINOR MODIFICATIONS IN THE DESIGN OF THE CONTRACT WITHOUT THE CONTRACTOR GETTING ADDITIONAL COMPENSATION.
- DO NOT SCALE THE DRAWINGS. DIMENSIONS ARE EITHER TO THE FACE OF FINISHED ELEMENTS OR TO THE CENTER LINE OF ELEMENTS, UNLESS NOTED OTHERWISE. CRITICAL DIMENSIONS SHALL BE VERIFIED AND NOTIFY THE CONSULTANT OF ANY DISCREPANCIES.
- THE CONTRACTOR SHALL BE RESPONSIBLE FOR DAILY CLEAN UP OF ALL TRADES AND REMOVE ALL DEBRIS FROM THE CONSTRUCTION SITE. AT THE COMPLETION OF THE PROJECT, THE CONTRACTOR SHALL THOROUGHLY CLEAN THE BUILDING, SITE, AND ANY OTHER SURROUNDING AREAS TO A BETTER THAN EXISTING CONDITION.
- THE CONTRACTOR IS RESPONSIBLE FOR ADEQUATELY BRACING AND PROTECTING ALL WORK DURING CONSTRUCTION AGAINST DAMAGE, BREAKAGE, COLLAPSE, ETC. ACCORDING TO APPLICABLE CODES, STANDARDS, AND GOOD CONSTRUCTION PRACTICES.
- THE CONTRACTOR SHALL MEET ALL OSHA REQUIREMENTS FOR ALL INSTALLATIONS.
- THE CONTRACTOR SHALL BE RESPONSIBLE FOR ALL DAMAGES TO THE EXISTING CONSTRUCTION AND REPAIR ALL DAMAGES TO BETTER THAN PROPOSED CONSTRUCTION. THE CONTRACTOR SHALL NOTIFY AVISTA OF ANY DAMAGE TO THE SITE OR ANY ADJACENT STRUCTURES AROUND THE PROJECT. THE CONSULTANT SHALL BE SOLE AND FINAL JUDGE AS TO THE QUALITY OF THE REPAIRED CONSTRUCTION. ANY ADDITIONAL MODIFICATIONS WHICH MUST BE MADE SHALL BE MADE AT THE CONTRACTOR'S EXPENSE.
- WHERE ONE DETAIL IS SHOWN FOR ONE CONDITION, IT SHALL APPLY FOR ALL LIKE OR SIMILAR CONDITIONS, EVEN THOUGH NOT SPECIFICALLY MARKED ON THE DRAWINGS OR REFERRED TO IN THE SPECIFICATIONS, UNLESS NOTED OTHERWISE.
- WHERE PROPOSED PAVING, CONCRETE SIDEWALKS OR PATHS MEET EXISTING CONSTRUCTION, THE CONTRACTOR SHALL MATCH THE EXISTING PITCH, GRADE, AND ELEVATION SO THE ENTIRE STRUCTURE SHALL HAVE A SMOOTH TRANSITION.
- THE CONTRACTOR SHALL MODIFY THE EXISTING STRUCTURE AS REQUIRED. WHERE THE EXISTING STRUCTURE MUST BE MODIFIED, GENERAL CONTRACTOR SHALL REPAIR TO ORIGINAL CONDITION. ALL WORK SHALL BE COVERED UNDER THE GENERAL CONTRACT.
- VERIFY ALL EXISTING DIMENSIONS PRIOR TO PERFORMING WORK.
- VERIFY LOCATION OF ALL BURIED UTILITIES PRIOR TO ANY EXCAVATION.
- THE GENERAL CONTRACTOR SHALL BE RESPONSIBLE FOR APPLYING FOR COMMERCIAL POWER IMMEDIATELY UPON AWARD OF CONTRACT. THE GENERAL CONTRACTOR IS REQUIRED TO KEEP ALL DOCUMENTATION RECEIVED FROM THE POWER COMPANY, ACKNOWLEDGING APPLICATION FOR POWER, WRITTEN AND VERBAL DISCUSSIONS WITH THE POWER COMPANY, ETC.
- THE GENERAL CONTRACTOR SHALL OBTAIN WRITTEN CONFIRMATION OF THE EXPECTED DATE OF COMPLETION OF THE POWER CONNECTION FROM THE POWER COMPANY.
- IF THE POWER COMPANY IS UNABLE TO PROVIDE THE POWER CONNECTION BY OWNER'S REQUIRED DATE, THE GENERAL CONTRACTOR SHALL PROVIDE AND MAINTAIN A TEMPORARY GENERATOR UNTIL THE POWER COMPANY CONNECTION IS COMPLETED. COSTS ASSOCIATED WITH THE TEMPORARY GENERATOR TO BE APPROVED BY THE OWNER.
- IF THE GENERAL CONTRACTOR FAILS TO TAKE NECESSARY MEASURES AS DESCRIBED IN NOTES 19, 20 AND 21 ABOVE, THE GENERAL CONTRACTOR SHALL PROVIDE A TEMPORARY GENERATOR AT NO COST TO THE OWNER.
- PLANS PART OF THIS SET ARE COMPLEMENTARY. INFORMATION IS NOT LIMITED TO ONE PLAN. DRAWINGS AND SPECIFICATIONS ARE INSTRUMENTS OF SERVICE AND SHALL REMAIN THE PROPERTY OF THE ARCHITECT, WHETHER THE PROJECT FOR WHICH THEY ARE MADE IS EXECUTED OR NOT. THEY ARE NOT TO BE USED BY THE OWNER ON OTHER PROJECTS OR EXTENSION TO THIS PROJECT EXCEPT BY AGREEMENT IN WRITING AND WITH APPROPRIATE COMPENSATION TO THE ARCHITECT. THESE PLANS WERE PREPARED TO BE SUBMITTED TO GOVERNMENTAL BUILDING AUTHORITIES FOR REVIEW FOR COMPLIANCE WITH APPLICABLE CODES AND IT IS THE SOLE RESPONSIBILITY OF THE OWNER AND/OR CONTRACTOR TO BUILD ACCORDING TO APPLICABLE BUILDING CODES.
- IF CONTRACTOR OR SUB-CONTRACTOR FIND IT NECESSARY TO DEVIATE FROM ORIGINAL APPROVED PLANS, THEN IT IS THE CONTRACTOR'S AND THE SUB-CONTRACTOR'S RESPONSIBILITY TO PROVIDE THE ARCHITECT WITH 4 COPIES OF THE PROPOSED CHANGES FOR HIS APPROVAL BEFORE PROCEEDING WITH THE WORK. IN ADDITION THE CONTRACTOR AND SUB-CONTRACTORS SHALL BE RESPONSIBLE FOR PROCURING ALL NECESSARY APPROVALS FROM THE BUILDING AUTHORITIES FOR THE PROPOSED CHANGES BEFORE PROCEEDING WITH THE WORK. THE CONTRACTOR AND SUB-CONTRACTORS SHALL BE RESPONSIBLE FOR PROCURING ALL NECESSARY INSPECTIONS AND APPROVALS FROM BUILDING AUTHORITIES DURING THE EXECUTION OF THE WORK.
- IN EVERY EVENT, THESE CONSTRUCTION DOCUMENTS AND SPECIFICATIONS SHALL BE INTERPRETED TO BE A MINIMUM ACCEPTABLE MEANS OF CONSTRUCTION BUT THIS SHALL NOT RELIEVE THE CONTRACTOR, SUB-CONTRACTOR, AND/OR SUPPLIER/MANUFACTURER FROM PROVIDING A COMPLETE AND CORRECT JOB WHEN ADDITIONAL ITEMS ARE REQUIRED TO THE MINIMUM SPECIFICATION. IF ANY ITEMS NEED TO EXCEED THESE MINIMUM SPECIFICATIONS TO PROVIDE A COMPLETE, ADEQUATE AND SAFE WORKING CONDITION, THEN IT SHALL BE THE DEEMED AND UNDERSTOOD TO BE INCLUDED IN THE DRAWINGS. FOR EXAMPLE, IF AN ITEM AND/OR PIECE OF EQUIPMENT REQUIRES A LARGER WIRE SIZE (I.E. ELECTRICAL WIRE), STRONGER OR LARGER PIPING, INCREASED QUANTITY (I.E. STRUCTURAL ELEMENTS), REDUCED SPACING, AND/OR INCREASED LENGTH (I.E. BOLT LENGTHS, BAR LENGTHS) THEN IT SHALL BE DEEMED AND UNDERSTOOD TO BE INCLUDED IN THE BID/PROPOSAL. THESE DOCUMENTS ARE MEANT AS A GUIDE AND ALL ITEMS REASONABLY INFERRED SHALL BE DEEMED TO BE INCLUDED.
- THESE CONTRACT DOCUMENTS AND SPECIFICATIONS SHALL NOT BE CONSTRUED TO CREATE A CONTRACTUAL RELATIONSHIP OF ANY KIND BETWEEN THE ARCHITECT AND THE CONTRACTOR.

LINE/ANTENNA NOTES

- ALL THREADED STRUCTURAL FASTENERS FOR ANTENNA SUPPORT ASSEMBLES SHALL CONFORM TO ASTM A307 OR ASTM A36. ALL STRUCTURAL FASTENERS FOR STRUCTURAL STEEL FRAMING SHALL CONFORM TO ASTM A325. FASTENERS SHALL BE 5/8" MIN. DIA. BEARING TYPE CONNECTIONS WITH THREADS EXCLUDED FROM THE PLANE. ALL EXPOSED FASTENERS, NUTS, AND WASHERS SHALL BE GALVANIZED OTHERWISE NOTED. CONCRETE EXPANSION ANCHORS SHALL BE HILTI KWIK BOLTS UNLESS OTHERWISE NOTED. ALL ANCHORS INTO CONCRETE SHALL BE STAINLESS STEEL.
- NORTH ARROW SHOWN ON PLANS REFERS TO TRUE NORTH. CONTRACTOR SHALL VERIFY MAGNETIC NORTH AND NOTIFY CONSULTANT OF ANY DISCREPANCY BEFORE STARTING CONSTRUCTION.
- PROVIDE LOCK WASHERS FOR ALL MECHANICAL CONNECTIONS FOR GROUND CONDUCTORS. USE STAINLESS STEEL HARDWARE THROUGHOUT.
- THOROUGHLY REMOVE ALL PAINT AND CLEAN ALL DIRT FROM SURFACES REQUIRING GROUND CONNECTIONS.
- MAKE ALL GROUND CONNECTIONS AS SHORT AND DIRECT AS POSSIBLE. AVOID SHARP BENDS. ALL BENDS TO BE A MIN. OF 8" RADIUS.
- FOR GROUNDING TO GROUND BARS USE A TWO-BOLT HOLE NEMA DRILLED CONNECTOR SUCH AS T&B 32007 OR APPROVED EQUAL.
- FOR ALL EXTERNAL GROUND CONNECTIONS, CLAMPS AND CADWELDS, APPLY A LIBERAL PROTECTIVE COATING OR AN ANTI-OXIDE COMPOUND.
- REPAIR ALL GALVANIZED SURFACES THAT HAVE BEEN DAMAGED BY THERMO-WELDING. USE ERICO T-319 GALVANIZING BAR/COLD GALVANIZING PAINT.

PROJECT INFORMATION

- THIS IS AN UNMANNED FACILITY AND RESTRICTED ACCESS EQUIPMENT AND WILL BE USED FOR THE TRANSMISSION OF RADIO SIGNALS FOR THE PURPOSE OF PROVIDING PUBLIC CELLULAR SERVICE.
- VERIZON WIRELESS CERTIFIES THAT THIS TELEPHONE EQUIPMENT FACILITY WILL BE SERVICED ONLY BY VERIZON WIRELESS EMPLOYEE SERVICE PERSONNEL FOR REPAIR PURPOSES ONLY. THIS FACILITY IS UNOCCUPIED AND NOT DESIGNED FOR HUMAN OCCUPANCY THUS IT IS NOT OPEN TO THE PUBLIC.
- THIS FACILITY WILL CONSUME NO UNRECOVERABLE ENERGY.
- NO POTABLE WATER SUPPLY IS TO BE PROVIDED AT THIS LOCATION.
- NO WASTE WATER WILL BE GENERATED AT THIS LOCATION.
- NO SOLID WASTE WILL BE GENERATED AT THIS LOCATION.
- VERIZON WIRELESS MAINTENANCE CREW (TYPICALLY ONE PERSON) WILL MAKE AN AVERAGE OF ONE TRIP PER MONTH AT ONE HOUR PER VISIT.

LEGEND

ABBREVIATIONS:

- (E) EXISTING
(P) PROPOSED

BUILDING/WALL/DETAIL SECTION:



LARGE SCALE DETAIL:

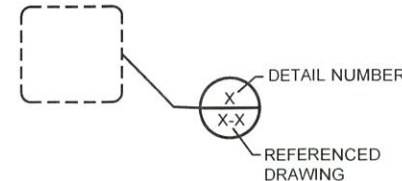

REFERENCE:

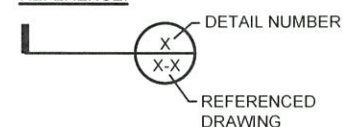

ELEVATION REFERENCE:

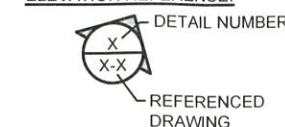

IMPORTANT NOTICE

THE EXISTING CONDITIONS REPRESENTED HEREIN ARE BASED ON VISUAL OBSERVATIONS AND INFORMATION PROVIDED BY OTHERS. ACOM CONSULTING CANNOT GUARANTEE THE CORRECTNESS NOR COMPLETENESS OF THE EXISTING CONDITIONS SHOWN AND ASSUMES NO RESPONSIBILITY THEREOF. CONTRACTOR AND HIS SUB-CONTRACTORS SHALL VISIT THE SITE AND VERIFY ALL EXISTING CONDITIONS AS REQUIRED FOR PROPER EXECUTION OF PROJECT. REPORT ANY CONFLICTS OR DISCREPANCIES TO THE CONSULTANT PRIOR TO CONSTRUCTION.

NO.	DATE	DRAWN	REVISION
A	05/19/23	KM	90% PCD REVIEW
B	08/03/23	KM	SURVEY UPDATE
C	06/04/24	KM	RFDS UPDATE



**HWY 6
SMALL CELL NODE 06**
WILSON RIVER HWY
TILLAMOOK, OR 97141

**GENERAL NOTES
AND SYMBOLS**

T-2

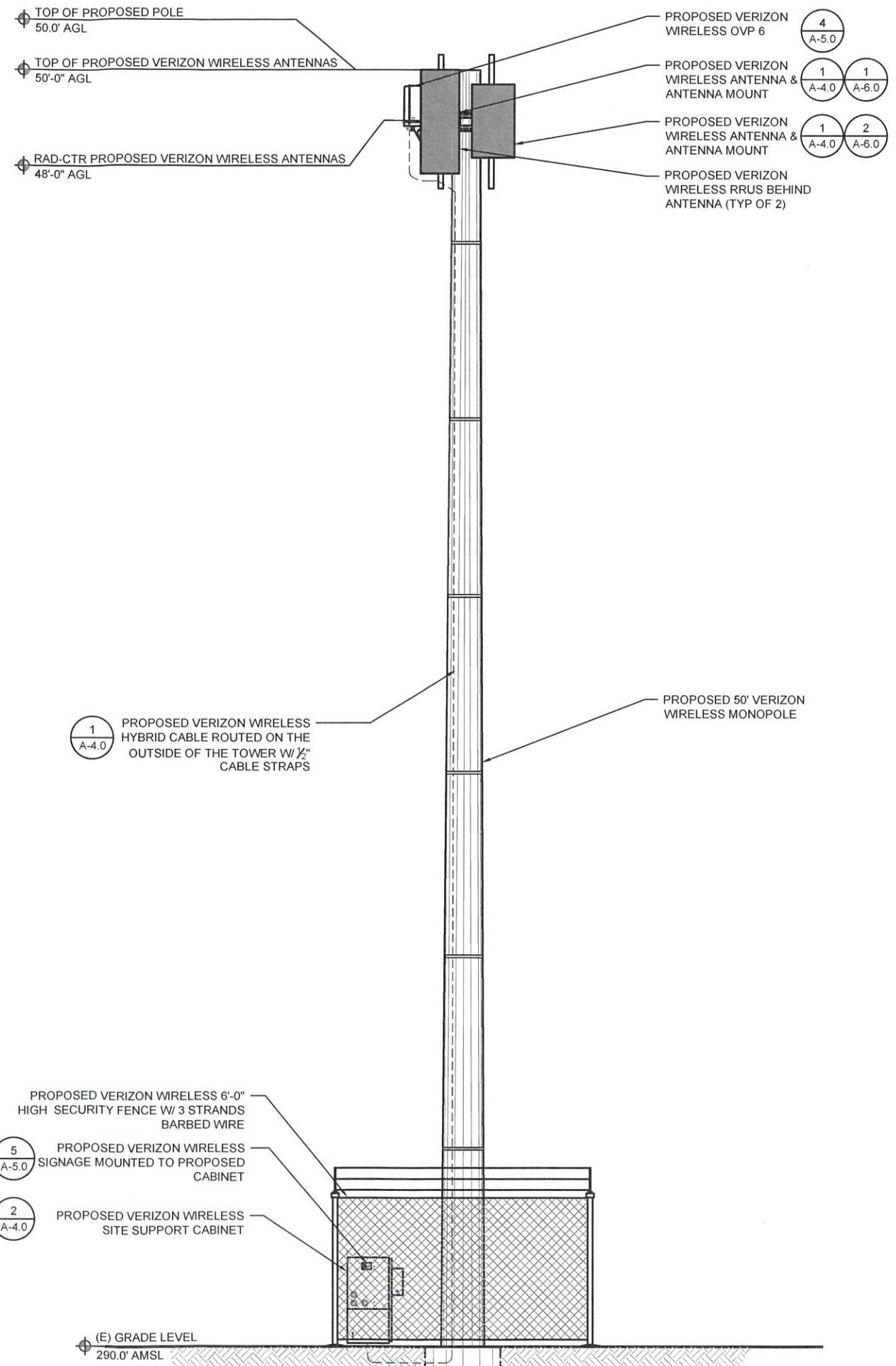
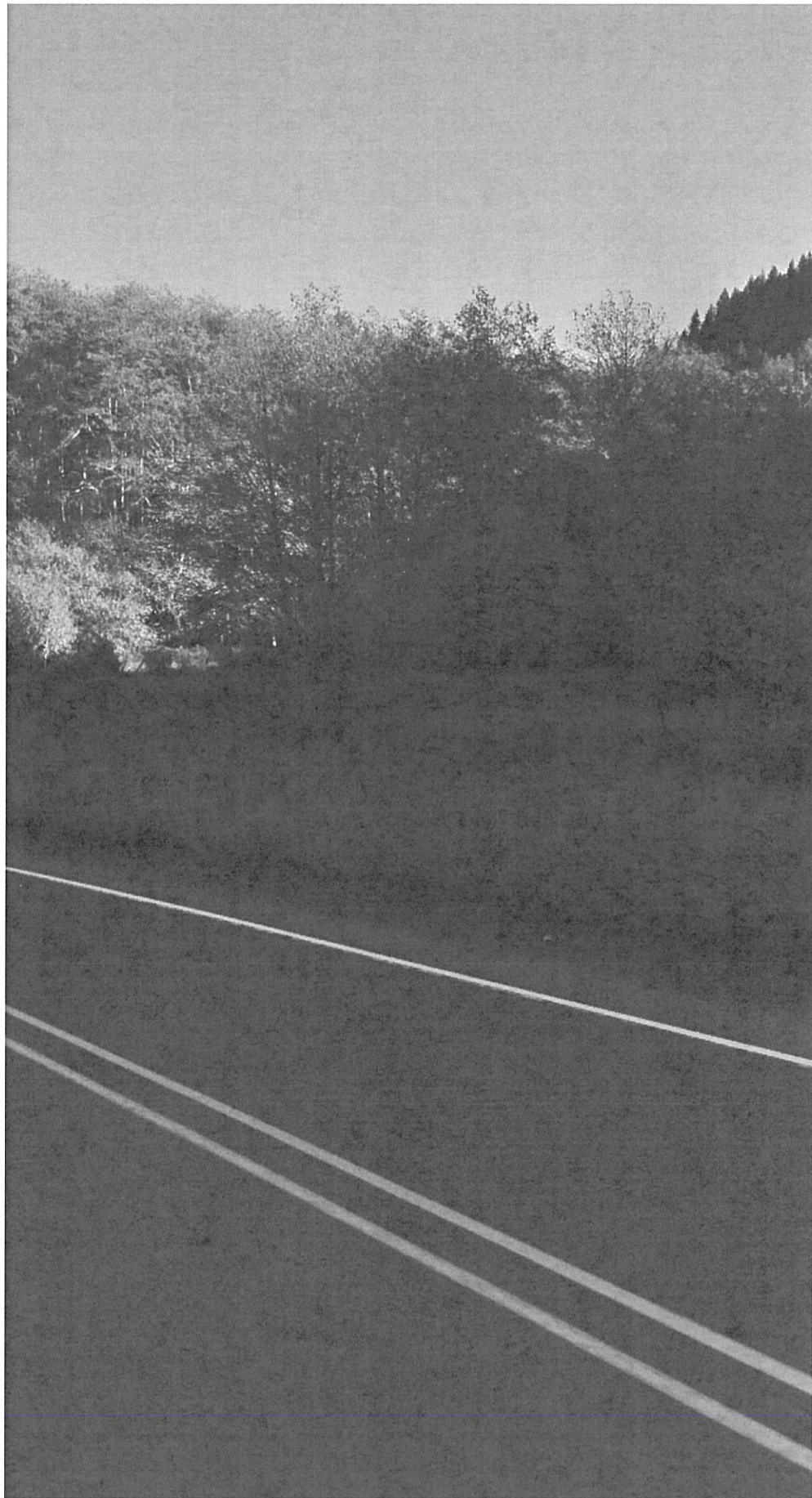

NO.	DATE	DRAWN	REVISION
A	05/19/23	KM	90% PCD REVIEW
B	08/03/23	KM	SURVEY UPDATE
C	06/04/24	KM	RFDS UPDATE

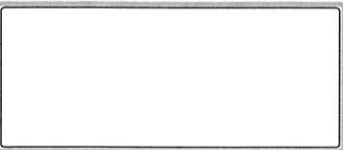
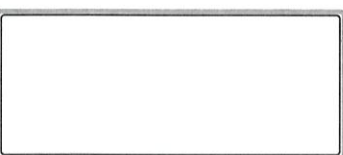

**HWY 6
SMALL CELL NODE 06**
WILSON RIVER HWY
TILLAMOOK, OR 97141

EXISTING & PROPOSED
ELEVATIONS

A-3.0

22"x34" SCALE: 3/8" = 1'-0"
11"x17" SCALE: 3/16" = 1'-0"

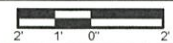

EXISTING ELEVATION 1

22"x34" SCALE: 3/8" = 1'-0"
11"x17" SCALE: 3/16" = 1'-0"

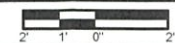

PROPOSED ELEVATION 2

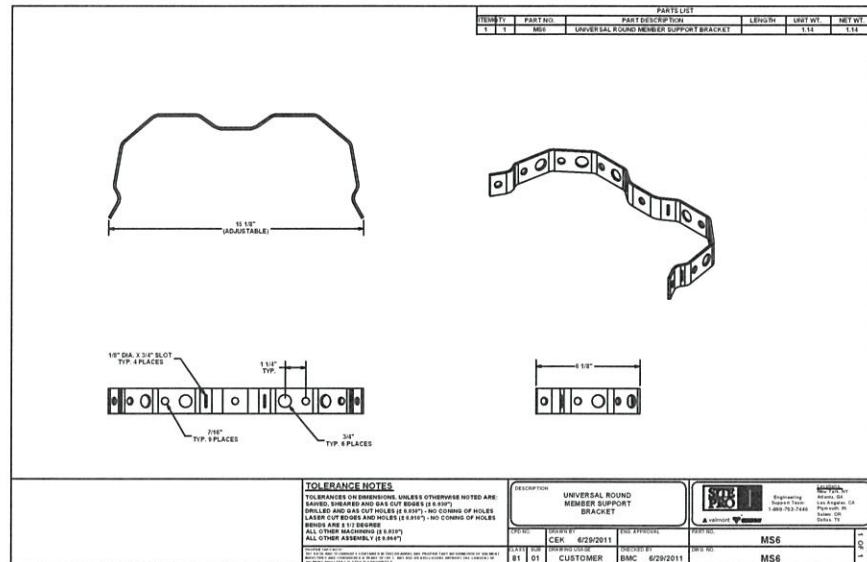

NOTE:
 1. ATTACH TO MONOPOLE WITH 1/2" BANDING PER MANUFACTURER'S RECOMMENDATIONS
 2. PROVIDE SNAP-IN HANGERS TO SUPPORT THE HYBRID CABLE(S)

22"x34" SCALE: NOT TO SCALE
 11"x17" SCALE: NOT TO SCALE

TOWER - HYBRID SUPPORT BRACKET 1

**Charles Universal Broadband Enclosures (CUBE)
 RL212 Series Remote Radio Head / Power Support Cabinets**

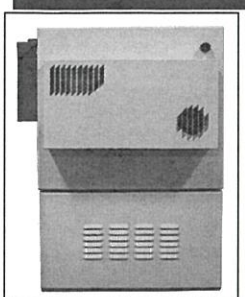

The CUBE-RL212 Series cabinet provides environmental protection for a wide variety of telecom applications, including wireless, fiber transport for cell site backhaul, and other remote outdoor applications where 48 VDC is required. The most common applications for these cabinets are to house power and battery backup for remote radio heads. Commercial AC power is converted to 48 VDC using a third-party rectifier (supports most major manufacturers). The separate battery chamber is designed for up to 100Ah Ni-Cd or VRLA batteries.

Specifications

Overall Dimensions	39"H x 26"W x 20"D
Equipment Chamber	24"H x 26"W x 20"D
Rack Space / Width	12RU / 19" EIA Standard
Door Lock	Padlockable, 216-Style Lock
AC Equipment	8 Position Load Center
Battery Chamber	15"H x 26"W x 20"D
Capacity	Supports 1 String 48V (or two 24V) 100Ah Ni-Cd or VRLA
Bonding & Grounding	8 Position, 2-Hole Ground Bar
Cable Entrance	(3) 1.75/2.5" Knockouts on Right-Hand Side (1) 1.75/2.5" and (2) 1.375" Knockouts on Bottom
Thermal Management	24VDC/48VDC 580 or 750 Watt Heat Exchangers
Construction	1/8" Welded Aluminum, Off-White Finish
Mounting	Wall or H-Frame, Pole Mount Kit optional (97-CABPMKIT), 10" Plinth optional (97-002176-A)



Charles Part #	Standard Mounting	Overall Dimensions (in)	RU	Equipment Chamber Dimensions (in)	Battery Chamber Dimensions (in)	Load Center	Thermal	Integrated Power	Weight Empty (lbs.)	Weight w/Ni-Cd Battery
CUBE-RL21221AB1	Wall/H-Frame	39x26x20	12	24x26x20	15x26x20	8 Position	580W 48VDC HX	GE SPS 48V (3) 20A Rectifiers	170	372
CUBE-RL21221AE2	Wall/H-Frame	39x26x20	12	24x26x20	15x26x20	8 Pos & Gen	580W 48VDC HX	GE SPS 48V (2) 20A Rectifiers	170	372
CUBE-RL21221AH1	Wall/H-Frame	39x26x20	12	24x26x20	15x26x20	8 Position	580W 48VDC HX	Etek 48V (2) 40A Rectifiers	165	367
CUBE-RL21221AH3	Wall/H-Frame	39x26x20	12	24x26x20	15x26x20	8 Position	580W 24VDC HX	Etek 24V (2) 60A Rectifiers	165	367
CUBE-RL21221AH4	Wall/H-Frame	39x26x20	12	24x26x20	15x26x20	8 Position	580W 48VDC HX	Etek 48V (1) 40A Rectifier	165	367
CUBE-RL21221AH5	Wall/H-Frame	39x26x20	12	24x26x20	15x26x20	8 Position	580W 48VDC HX	None	150	352
CUBE-RL21221AH7	Wall/H-Frame	39x26x20	12	24x26x20	15x26x20	8 Position	580W 24VDC HX	Etek 24V (2) 40A Rectifiers	165	367
CUBE-RL21221AH8	Wall/H-Frame	39x26x20	12	24x26x20	15x26x20	8 Position	580W 48VDC HX	GE Infinity D 48V, No Rectifiers	180	385
CUBE-RL21221DB1	Wall/H-Frame	39x26x20	12	24x26x20	15x26x20	8 Position	750W 48VDC HX	None	150	352
CUBE-RL21221DB2	Wall/H-Frame	39x26x20	12	24x26x20	15x26x20	8 Position	750W 48VDC HX	GE Infinity D 48V, (2) 50A Rectifiers	165	367
CUBE-RL21221DL1	Wall/H-Frame	39x26x20	12	24x26x20	15x26x20	8 Pos & Gen	750W 48VDC HX	None	150	385
CUBE-RL21221DL2	Wall/H-Frame	39x26x20	12	24x26x20	15x26x20	8 Pos & Gen	750W 48VDC HX	GE Infinity D 48V	180	385

For additional product information, please visit www.charlesindustries.com
 INNOVATIVE ENCLOSED SOLUTIONS™

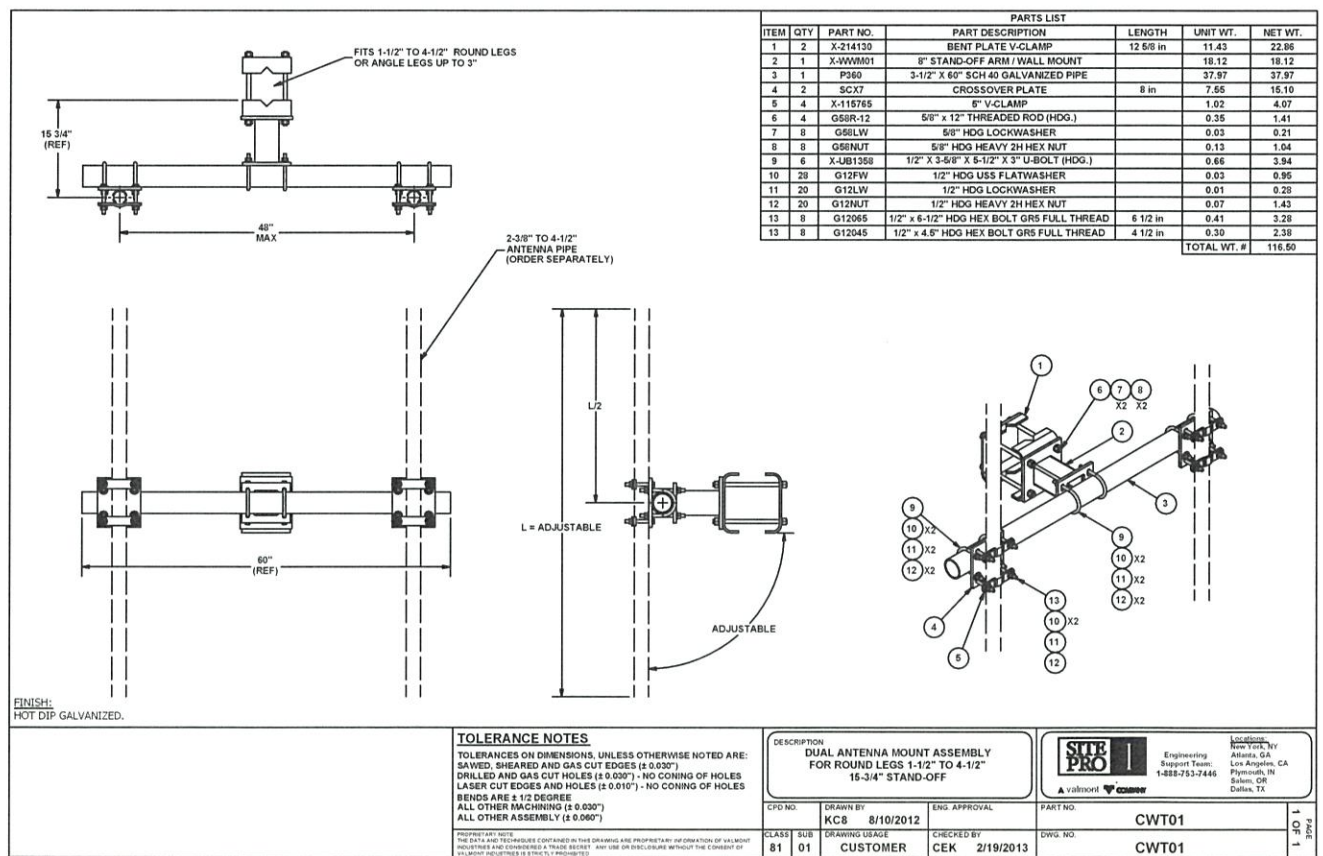

TOLERANCE NOTES
 TOLERANCES ON DIMENSIONS, UNLESS OTHERWISE NOTED ARE:
 SAWED, SHEARED AND GAS CUT EDGES (± 0.030")
 DRILLED AND GAS CUT HOLES (± 0.030") - NO CONING OF HOLES
 LASER CUT EDGES AND HOLES (± 0.010") - NO CONING OF HOLES
 BENDS ARE ± 1/2 DEGREE
 ALL OTHER MACHINING (± 0.030")
 ALL OTHER ASSEMBLY (± 0.060")

DESCRIPTION	DUAL ANTENNA MOUNT ASSEMBLY FOR ROUND LEGS 1-1/2" TO 4-1/2" 15-3/4" STAND-OFF
CPD NO.	81 01
CLASS	CUSTOMER
DESIGNED BY	KCB
DATE	8/10/2012
ENG. APPROVAL	
CHECKED BY	CEK
DATE	2/19/2013
PART NO.	CWT01
DWG. NO.	CWT01

22"x34" SCALE: NOT TO SCALE
 11"x17" SCALE: NOT TO SCALE

ANTENNA MOUNT DETAIL 2

EQUIPMENT CABINET SPECIFICATIONS 3

**Ordering Information – Infinity D Power System
 Dual Voltage, Modular Power System**

Infinity-D may be configured as a +24V or -48V single voltage power system or as a "dual voltage" power system that supports rectifiers and converters. The primary voltage is supported by +24V or -48V rectifiers and battery reserve, while secondary voltage is supported by DC/DC converters. The primary voltage capacity is 1,600A at both 24V and 48V. Secondary voltage capacity is up to 300A per system expansion module.

- Features**
- Infinity Rectifiers for +24V and -48V applications
 - Modular architecture for easy growth and low cost
 - DC/DC converter support for dual voltage systems
 - DC distribution in each system module for efficient scalability
 - Temperature hardened harsh environments (-40°C to +75°C)
 - Compact size: 8" (203mm) high, 16.9" (429mm) deep
 - Adjustable frame mounting for 19", 23" and 26" applications
 - Battery panel for battery connection and LVBD option.
 - Plug-N-Play Pulsar Plus controller with Web based interface for local and remote (CO-LAN) access.
 - Distribution options include 3A-400A bullet style circuit breakers and GMT fuses

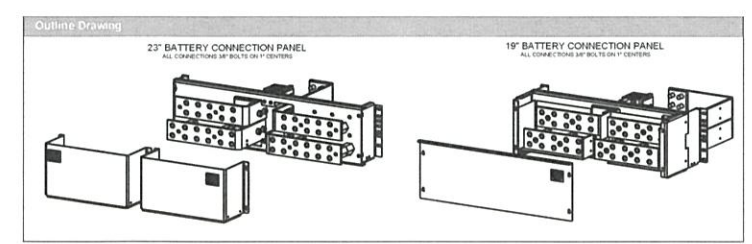
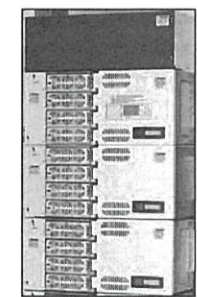

Output	Ordering Code	Model	Frame	Picture
200A	CC106151107	H2007001 G003, G021D, G223	No Frame	
	CC106150100	H2007001 G003, G021F, G223	System width 23"	
			System width 19"	

GE INFINITY D 49V PDU SPECIFICATIONS 4

NO.	DATE	DRAWN	REVISION
A	05/19/23	KM	90% PCD REVIEW
B	08/03/23	KM	SURVEY UPDATE
C	06/04/24	KM	RFDS UPDATE



**HWY 6
 SMALL CELL NODE 06**
 WILSON RIVER HWY
 TILLAMOOK, OR 97141

**CONSTRUCTION
 DETAILS**

A-4.0

MANUFACTURER: ERICSSON
 MODEL: RADIO 4890
 HEIGHT: 21.80"
 WIDTH: 15.70"
 DEPTH: 7.50"
 WEIGHT: 84 LBS
 COLOR: OFF-WHITE

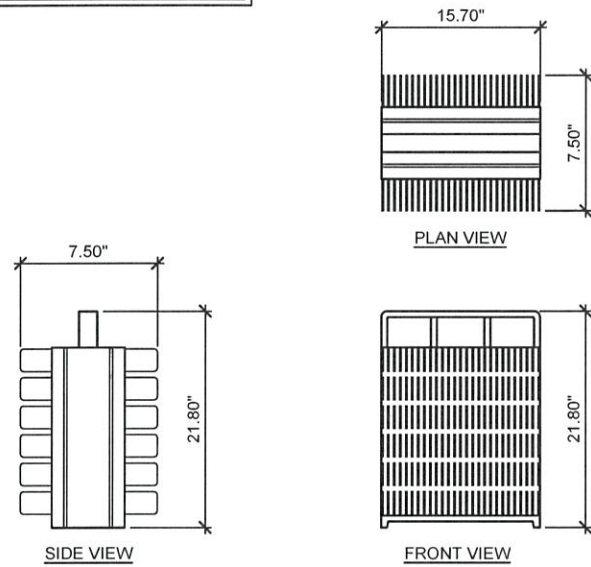

22"x34" SCALE: NOT TO SCALE
 11"x17" SCALE: NOT TO SCALE

4890 RADIO 1

MANUFACTURER: ERICSSON
 MODEL: RADIO 4490
 HEIGHT: 15.00"
 WIDTH: 13.00"
 DEPTH: 9.00"
 WEIGHT: 70 LBS
 COLOR: OFF-WHITE

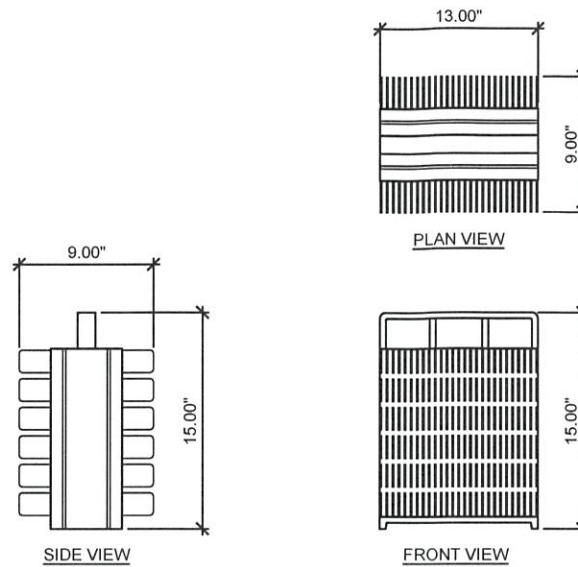

22"x34" SCALE: NOT TO SCALE
 11"x17" SCALE: NOT TO SCALE

4490 RADIO 2

22"x34" SCALE: NOT TO SCALE
 11"x17" SCALE: NOT TO SCALE

NOT USED 3

NO.	DATE	DRAWN	REVISION
A	05/19/23	KM	90% PCD REVIEW
B	08/03/23	KM	SURVEY UPDATE
C	06/04/24	KM	RFDS UPDATE



MANUFACTURER: RAYCAP
 MODEL: RCMDC-3315-PF-48
 HEIGHT: 29.93"
 WIDTH: 15.73"
 DEPTH: 10.30"
 WEIGHT: 32.00 LBS (W/ MOUNT)
 COLOR: LIGHT GRAY

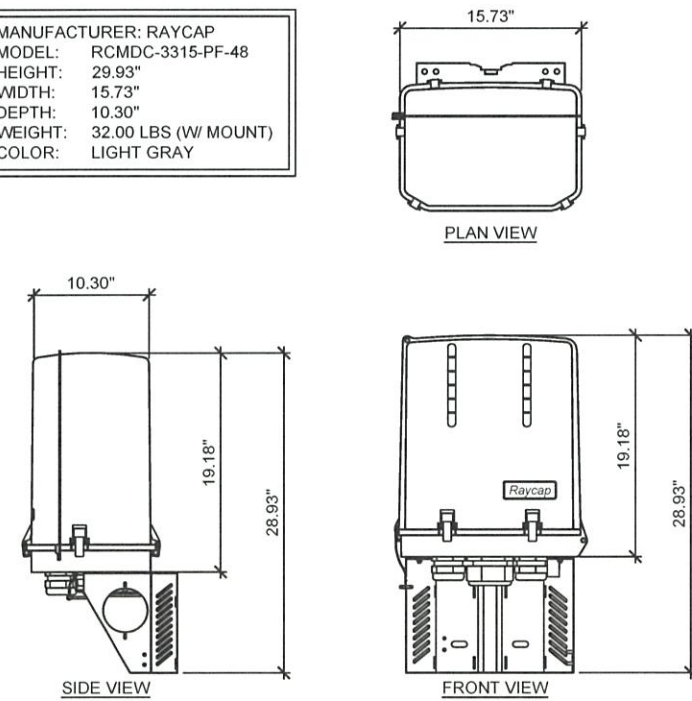

22"x34" SCALE: NOT TO SCALE
 11"x17" SCALE: NOT TO SCALE

RAYCAP OVP 6 4

THE CONTRACTOR WILL ENSURE ALL SIGNAGE AT SITE LOCATION TO MEET WITH FCC STANDARDS AND REQUIREMENTS.

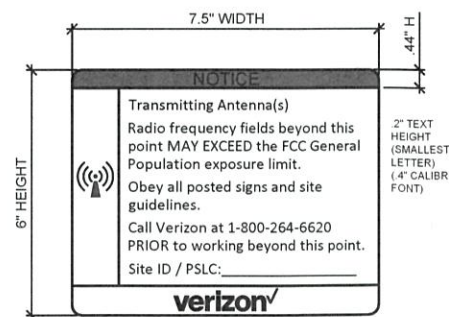

RF NOTICE SIGN
 NOT TO SCALE

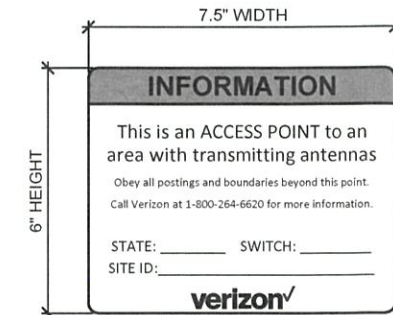

RF INFORMATION SIGN
 NOT TO SCALE

22"x34" SCALE: NOT TO SCALE
 11"x17" SCALE: NOT TO SCALE

RF SIGNAGE DETAILS 5

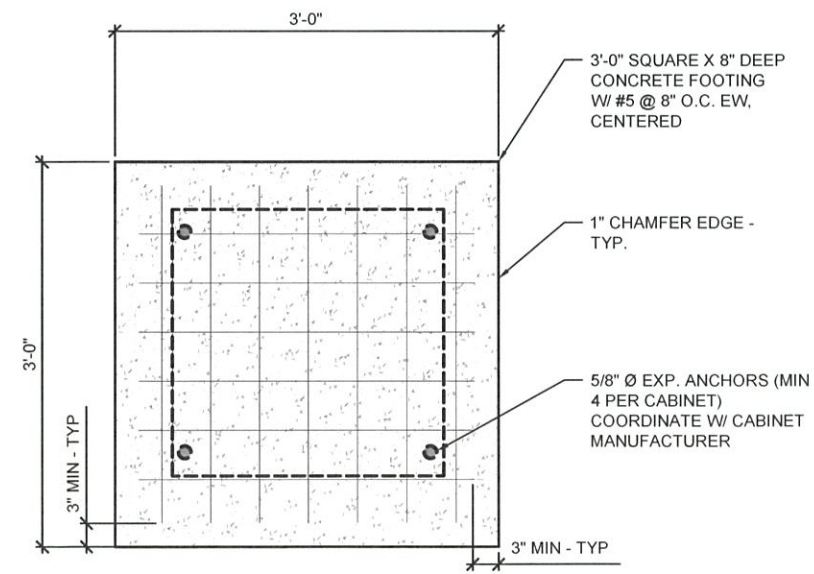

CONCRETE PAD DETAIL 6

**HWY 6
 SMALL CELL NODE 06**
 WILSON RIVER HWY
 TILLAMOOK, OR 97141

**CONSTRUCTION
 DETAILS**

A-5.0

TECHNICAL SPECIFICATIONS AIR 6419 B41

PRODUCT NUMBER: KRD 901 212/11

ADVANCED ANTENNA SYSTEM
 Operating frequency band: 3GPP Band 41, 2496 – 2690 MHz (full band)
 Instantaneous bandwidth: 194 MHz
 Output Power: 320 W
 EIRP max: 79 dBm
 Antenna configuration: (3x1) x (4x8)
 Architecture: 64T64R connected to an array of dual polarized antenna elements.

Modulation: Downlink Up to 256 QAM.
 Uplink Up to 64 QAM.

Multi-antenna beamforming functionality*:
 Downlink SU-MIMO
 Downlink MU-MIMO Up to 16 layers per carrier.
 Uplink SU-MIMO
 Uplink MU-MIMO Up to 16 layers per carrier.
 Cell shaping Pre-defined cell or broadcast beam shapes*; Macro, Hotspot and High-rise.
 Digital down-tilt Continuously adjustable for macro scenario, fixed for Hotspot and High-rise scenario.

Mechanical specifications*
 Weight: 31 kg (68.5 lbs) excluding installation kit
 Size (H x W x D): 876 x 506 x 203 mm (34.5" x 20.0" x 8.0") (including protrusions)
 852 x 506 x 160 mm (33.6" x 20.0" x 6.3") (excluding protrusions)

Operational specifications*
 Wind Load Maximum: 653 N (front), 110 N (side) @ 42 m/s wind speed (pole installed)
 Operating Temperature Range: -40° to +55° C
 Solar radiation: ≤ 1,120 W/m²
 Relative humidity: 2% to 100%
 Absolute humidity: 0.26 to 40 g/m³
 IP Classification: IP65

Main Interfaces
 Baseband: Two eCPRI interfaces using 25G SFP+ ports with link capacity 25 Gb/s each. One 25 Gb/s eCPRI interface is sufficient for up to 100 MHz carrier bandwidth and 16 layers.

Power Supply: -48 V DC (3-wire or 2-wire) via a connector.
 Maximum fuse rating is 50 A.

Mounting: Optional mechanical tilt and swivel installation kit for wall and pole mounting.

Handling: Handle for lifting and hoisting.

* Additional scenarios, cells or broadcast beam shapes possible with future software releases. Refer detailed description for more details on NR and EIRP for specific scenarios.

Final
 Telefonaktiebolaget LM Ericsson
 SE-164 80 Stockholm, Sweden
 www.ericsson.com

© Ericsson 2022



MX12FRO445-01

NWAV™ X-Pol 12-Port Antenna

X-Pol 12-Port 4 ft, 45° Fast Roll Off, with Smart Bias Ts, 698-2690 MHz:

4 ports 698-894 MHz, 8 ports 1695-2690 MHz

- 12-Port antenna offering the same functionality as 2 Hex Port antennas in a single unit
- Fast Roll Off (FRO™) Azimuth beam patterns improves intra-inter-cell SINR
- Optimized form factor for reduced wind loading
- Fully integrated (iRETs) with independent RET control for low band and mid band
- Excellent passive intermodulation (PIM) performance reduces harmful interference.
- Suitable for 3G, 4G, and 5G interface technologies
- Integrated Smart Bias-Ts reduce leasing costs

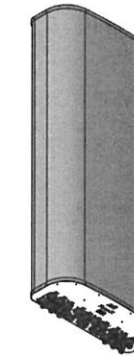

Fast Roll-Off antennas increase data throughput without compromising coverage

The horizontal beam produced by Fast Roll-Off (FRO) technology increases the Signal to Interference & Noise Ratio (SINR) by eliminating overlap between sectors.

Non-FRO antenna Large traditional antenna pattern overlap creates harmful interference. **JMA FRO antenna** JMA's FRO antenna pattern minimizes overlap, thereby minimizing interference.

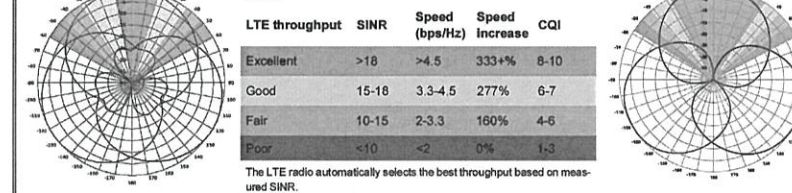

Electrical specification (minimum/maximum)	Ports 1, 2, 3, 4				Ports 5, 6, 7, 8, 9, 10, 11, 12			
	698-806	806-894	1695-1880	1850-1990	1920-2180	2300-2360	2496-2690	
Frequency bands, MHz	698-806	806-894	1695-1880	1850-1990	1920-2180	2300-2360	2496-2690	
Polarization	± 45°				± 45°			
Average gain over all tilts, dBi	12.7	13.0	15.9	16.2	16.8	16.8	16.6	
Horizontal beamwidth (HBW), degrees ¹	46	43	40	40	36	31	29	
Front-to-back ratio, co-polar power @180°± 30°, dB	>25.0	>25.0	>25.0	>25.0	>25.0	>25.0	>25.0	
X-Pol discrimination (CPR) at boresight, dB	>20.0	>18.0	>19	>18	>18	>18	>18	
Vertical beamwidth (VBW), degrees ¹	31.0	27.0	12.0	11.4	11.0	10.0	9.0	
Electrical downtilt (EDT) range, degrees	2-16				0-9			
First upper side lobe (USLS) suppression, dB ¹	≤-18.0	≤-18.0	≤-18.0	≤-18.0	≤-18.0	≤-18.0	≤-18.0	
Cross-polar isolation, port-to-port, dB ¹	25	25	25	25	25	25	25	
Max VSWR / return loss, dB	1.5:1 / -14.0				1.5:1 / -14.0			
Max passive intermodulation (PIM), 2x20W carrier, dBc	-153				-153			
Max input power per any port, watts	300				250			
Total composite power all ports, watts					1500			

¹ Typical value over frequency and tilt

©2024 JMA Wireless. All rights reserved. This document contains proprietary information. All products, company names, brands, and logos are trademarks™ or registered® trademarks of their respective holders. All specifications are subject to change without notice. +1 315.431.7100 customerservice@jmawireless.com

01/02/24 V2.0

Page1

NO.	DATE	DRAWN	REVISION
A	05/19/23	KM	90% PCD REVIEW
B	08/03/23	KM	SURVEY UPDATE
C	06/04/24	KM	RFDS UPDATE

CLIENT:

verizon

A&E CONSULTANT, SITE ACQUISITION AND PERMITTING

Acom
 CONSULTING, INC

VECTOR
 ENGINEERS

**HWY 6
 SMALL CELL NODE 06**
 WILSON RIVER HWY
 TILLAMOOK, OR 97141

ANTENNA DETAILS

A-6.0

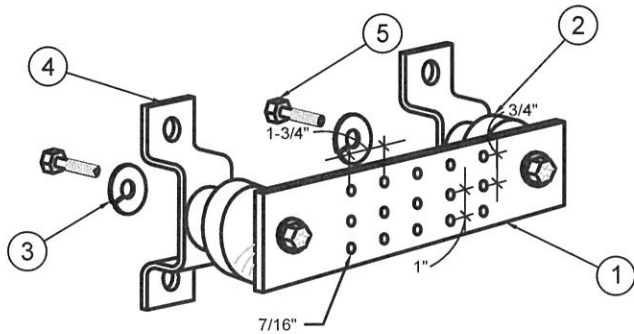

1. GALVANIZED STEEL GROUND BUSBAR, 1/4" X 4" X 6".
2. INSULATORS, MEET REQUIREMENTS OF UL 94 VO FOR SELF-EXTINGUISHING MATERIALS.
3. 3/8" LOCKWASHERS.
4. MOUNTING BRACKET.
5. 3/8-11 X 1" HHCS BOLTS.

22"x34" SCALE: NOT TO SCALE
11"x17" SCALE: NOT TO SCALE

GROUND BAR DETAIL 1

1. GROUNDING SHALL COMPLY WITH THE APPLICABLE EDITION OF THE NATIONAL ELECTRICAL CODE AS RECOGNIZED BY THE JURISDICTION.
2. ALL GROUNDING METHODS SHALL CONFORM TO THE CURRENT VERIZON STANDARDS.
3. MASTER GROUND BARS (MGB) SHALL BE GALVANIZED STEEL, 4" x 6" MAX.
4. MINIMUM BENDING RADIUS FOR GROUND CONDUCTOR IS 8", WHEN BENDING IS NECESSARY. GROUND CONDUCTORS ARE TO BE AS STRAIGHT AS POSSIBLE.
5. NO SPLICES PERMITTED IN GROUND CONDUCTORS.
6. ALL GROUNDING CONNECTORS TO BE CLEAN AND FREE OF PAINT AT THEIR MATING SURFACES AND INSTALLED PER MANUFACTURER'S RECOMMENDATIONS. USE PENETROX OR EQUIVALENT ANTIOXIDANT GREASE.
7. ALL GROUND BAR CONNECTIONS ARE TO BE 2 HOLE LUG COMPRESSION TYPE. STACKED CONNECTIONS ARE NOT ACCEPTABLE. BACK TO BACK CONNECTIONS ON OPPOSITE SIDES OF THE GROUND BAR WILL BE PERMITTED.
8. ENSURE ALL MECHANICAL CONNECTORS ARE TORQUED TO THE MANUFACTURER'S SPECIFIED VALUES.
9. IF EXISTING GROUND ROD IS NOT PRESENT, NEW GROUND ROD SHALL MEET AVISTA STANDARDS.
10. MULTIPLE BONDS ON GROUND RODS TO BE SEPARATED BY AT LEAST 6".
11. MAXIMUM RESISTANCE OF THE COMPLETED GROUND SYSTEM SHALL NOT EXCEED A RESISTANCE OF 5 OHMS TO EARTH.
12. GROUND WIRES SHALL NOT BE INSTALLED THROUGH HOLES IN ANY METAL OBJECTS OR SUPPORTS TO PRECLUDE ESTABLISHING A "CHOKE" POINT.
13. FERROUS METAL CLIPS WHICH COMPLETELY SURROUND THE GROUND WIRE SHALL NOT BE USED. METAL CLIPS THAT DO NOT COMPLETELY SURROUND THE GROUND WIRE OR PLASTIC ARE ACCEPTABLE.

22"x34" SCALE: NOT TO SCALE
11"x17" SCALE: NOT TO SCALE

GROUNDING NOTES 2

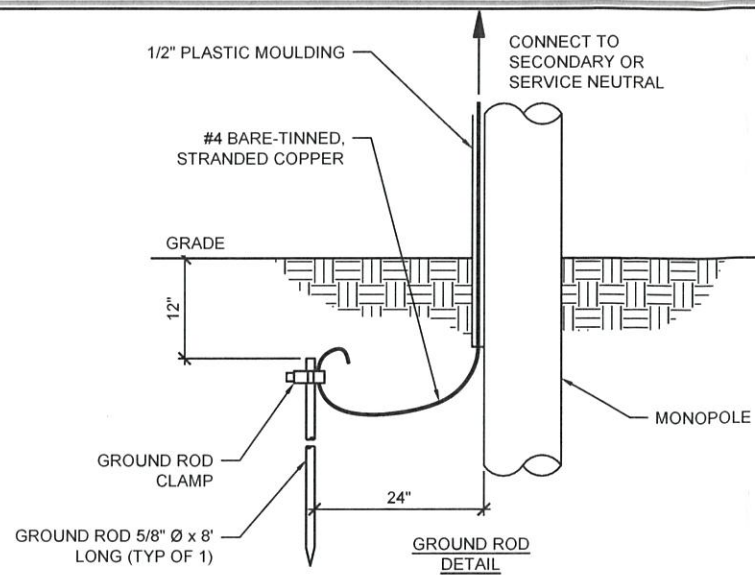

SYMBOL	DESCRIPTION
	MASTER GROUND BAR
	MECHANICAL CONNECTION
	4/0 BARE-TINNED, STRANDED COPPER, MIN. 36" BELOW GRADE OR 6" BELOW FROSTLINE

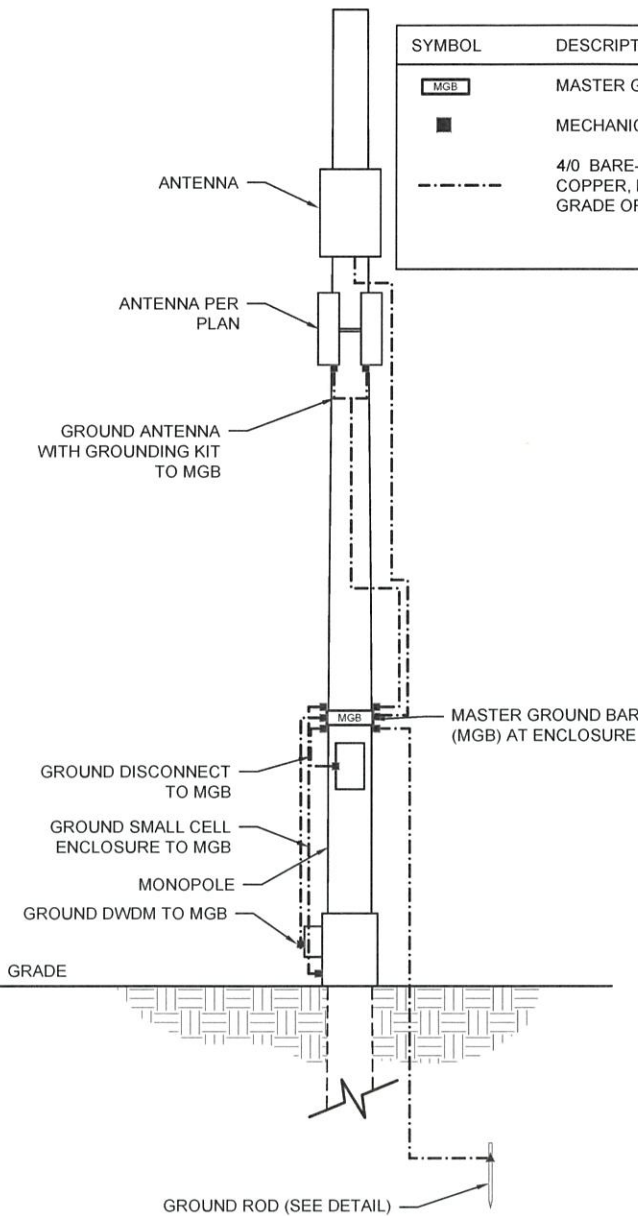

IMAGE IS FOR DIAGRAMMATIC PURPOSES AND MAY NOT REFLECT ACTUAL POLE AND ANTENNAS

22"x34" SCALE: NOT TO SCALE
11"x17" SCALE: NOT TO SCALE

GROUNDING DIAGRAM 3

PANEL NAME	VERIZON	MANUFACTURER	SQ-D
VOLTS	120/240	MODEL NUMBER	QO816L100RB
PHASE	1	WIRE	3
BUS RATING	60 AMPS (MAX)	ENCLOSURE RATING	NEMA 4X
MAIN BREAKER	60 AMPS	MATERIAL	ALUMINUM
		POSITIONS	8 CIRCUITS

LOAD	POS	BRK	A
4449	1	15	120
8843	2	15	120
RECEPT	3	15	120
HVAC	4	20	120
RACK EQUIP	5	20	120
SPACE	6	--	120
SPACE	7	--	120
SPACE	8	--	120

NOTES:
PANEL IS LOCATED ON EQUIPMENT CABINET

LOAD:

	RECEPT	8843	4449	TELCO EQUIP:
	180			320 W
	-0-			120 W
	1500			TOTAL 440 W
	440			
	650			TOTAL 2770W

TOTAL LOAD: 2770VA/240V = 11.54A

22"x34" SCALE: NOT TO SCALE
11"x17" SCALE: NOT TO SCALE

PANEL SCHEDULE 3

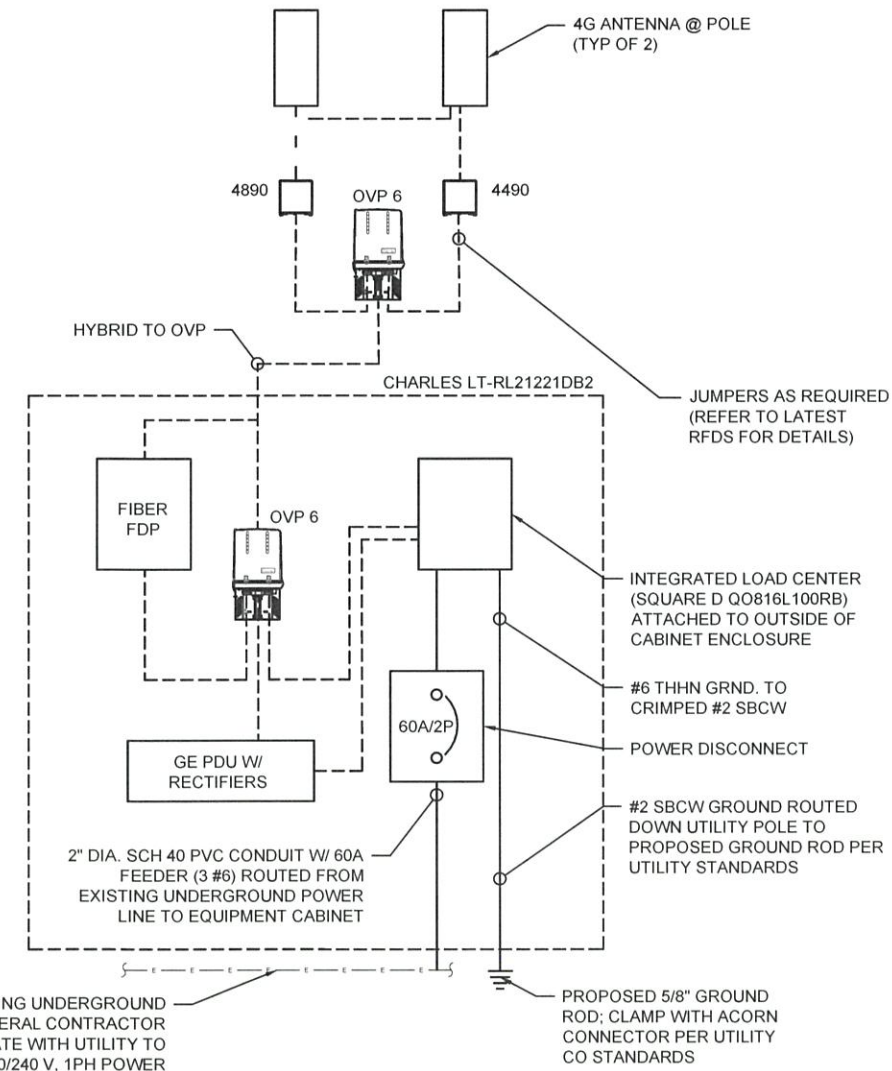

22"x34" SCALE: NOT TO SCALE
11"x17" SCALE: NOT TO SCALE

TYPICAL ONE-LINE DIAGRAM 4

NO.	DATE	DRAWN	REVISION
A	05/19/23	KM	90% PCD REVIEW
B	08/03/23	KM	SURVEY UPDATE
C	06/04/24	KM	RFDS UPDATE

CLIENT:



**HWY 6
SMALL CELL NODE 06**
WILSON RIVER HWY
TILLAMOOK, OR 97141

**GROUNDING
DETAILS**

E-1.0

**Alpha
(Proposed)**

**Beta
(Proposed)**

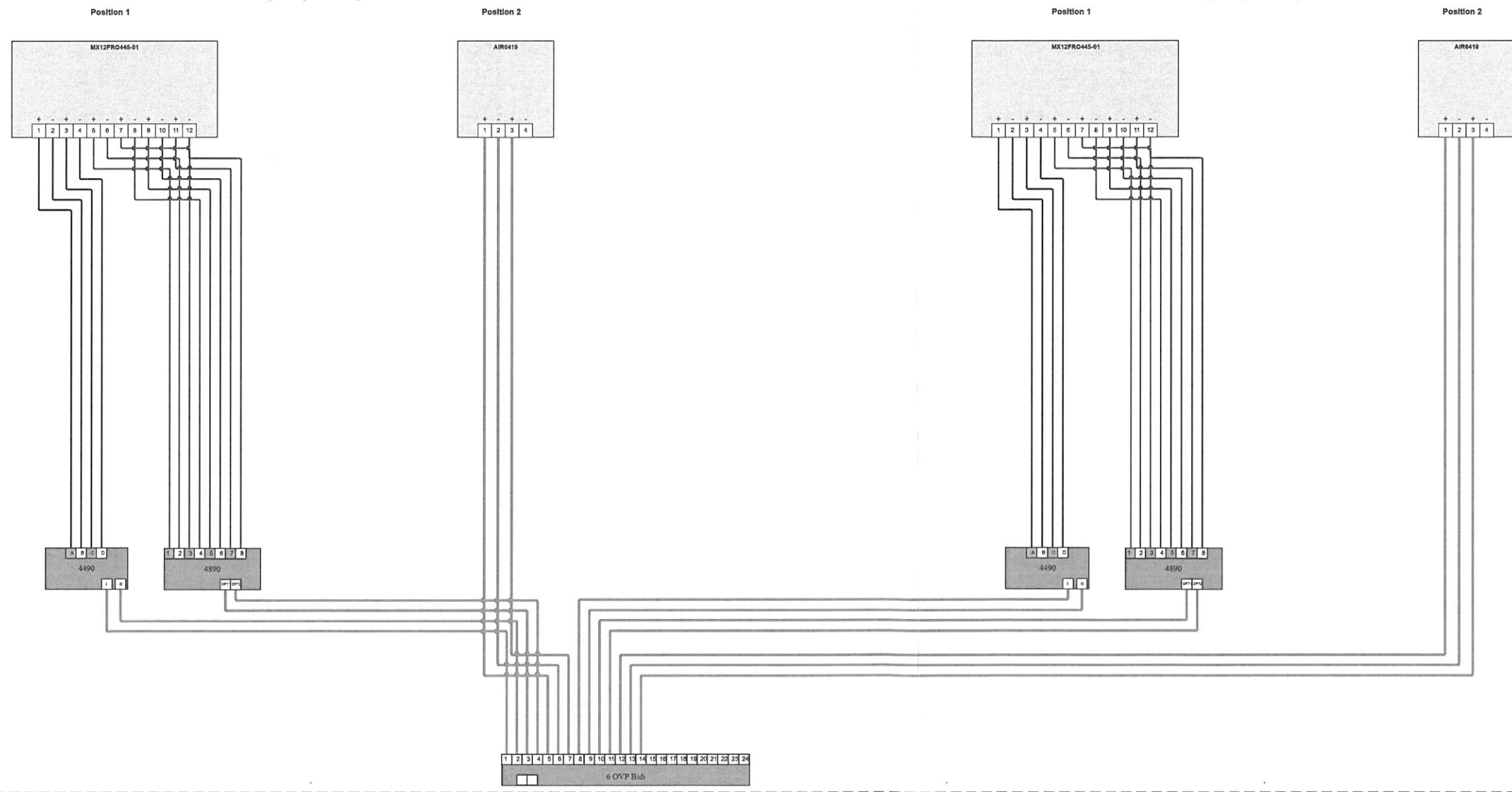

Sector design
Shelter

NO.	DATE	DRAWN	REVISION
A	05/19/23	KM	90% PCD REVIEW
B	08/03/23	KM	SURVEY UPDATE
C	06/04/24	KM	RFDS UPDATE



**HWY 6
SMALL CELL NODE 06**
WILSON RIVER HWY
TILLAMOOK, OR 97141

**ANTENNA
CONFIGURATION**

RF-1

HWY OR-6 wireless nodes

RF Design: John Gilbert



Verizon confidential and proprietary. Unauthorized disclosure, reproduction or other use prohibited.

Propagation Maps:

There are several methods for determining where coverage gaps exist within a given network of wireless sites. One of these is through the use of propagation maps. The propagation map is a computer simulation of the strength of Verizon Wireless signals at a given height and location in the context of the network. Propagation maps are one tool for determining whether a proposed site will meet the coverage objective and what antenna height is needed to provide robust service for Verizon Wireless customers. The radio propagation tool is designed to take factors such as terrain, tree coverage, and existing buildings into account, so that it depicts a reliable estimate of coverage that would be provided by a proposed site. The propagation maps that follow show three levels of service, designated as the following colors:

- Green - a level of service adequate for providing good indoor coverage and outdoor coverage.
- Yellow - a level of service adequate for providing good coverage outdoors but moderate indoor coverage/inside a car
- Red - a level of service adequate for providing moderate outdoor coverage but unreliable indoor coverage/inside a car.
- No color: unreliable signal strength, may not be not capable of reliably making and holding a call depending on environment

Propagation Maps:

In order to provide excellent service, the antenna heights and site locations should provide a line of sight along the highway. Two multi-frequency antennas are being proposed at each location in order to provide wireless voice and data services in a high-traffic corridor that is otherwise unserved. The proposed antenna heights are the minimum predicted to be required for continuous service when combined with other future improvements.

Overview map of wireless coverage along OR-6

Current service levels along Highway OR-6



Predicted service levels after constructing 9 small cells

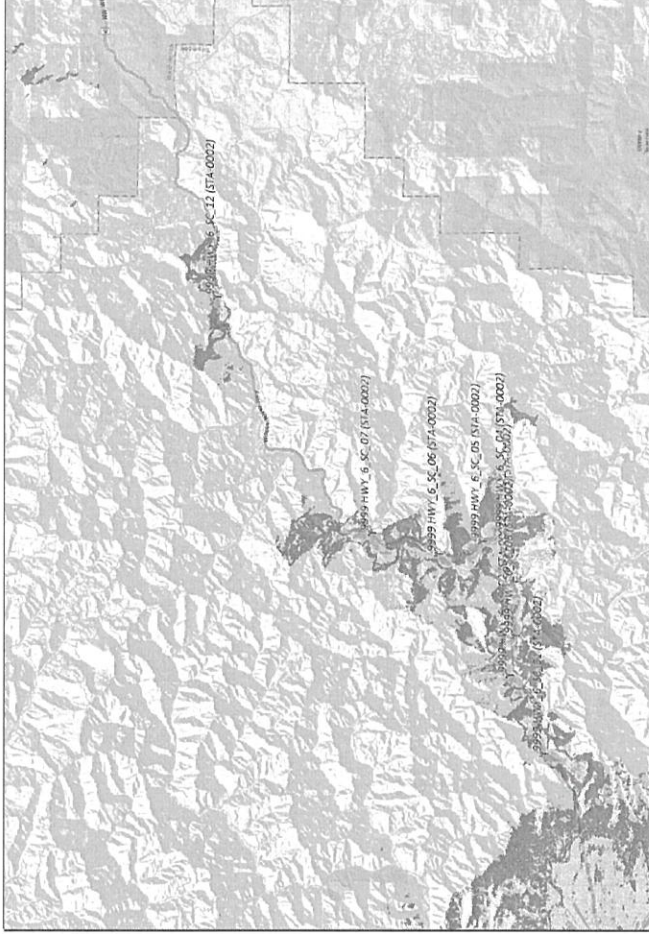

Summary

- HWY OR-6 is currently significantly underserved by wireless coverage, even though there is a substantial amount of traffic every day.
- The lack of existing wireless facilities in the area contributes to lack of coverage. The new small cells will provide much needed coverage in areas that would be difficult to serve using conventional tower-based transmitters.
- These sites will not only help improve customer experience but also help public safety and emergency services by allowing communication in an otherwise cut-off area.



Nodes 1, 2, and 8



Nodes 3, 4, 5, and 6



Node 7

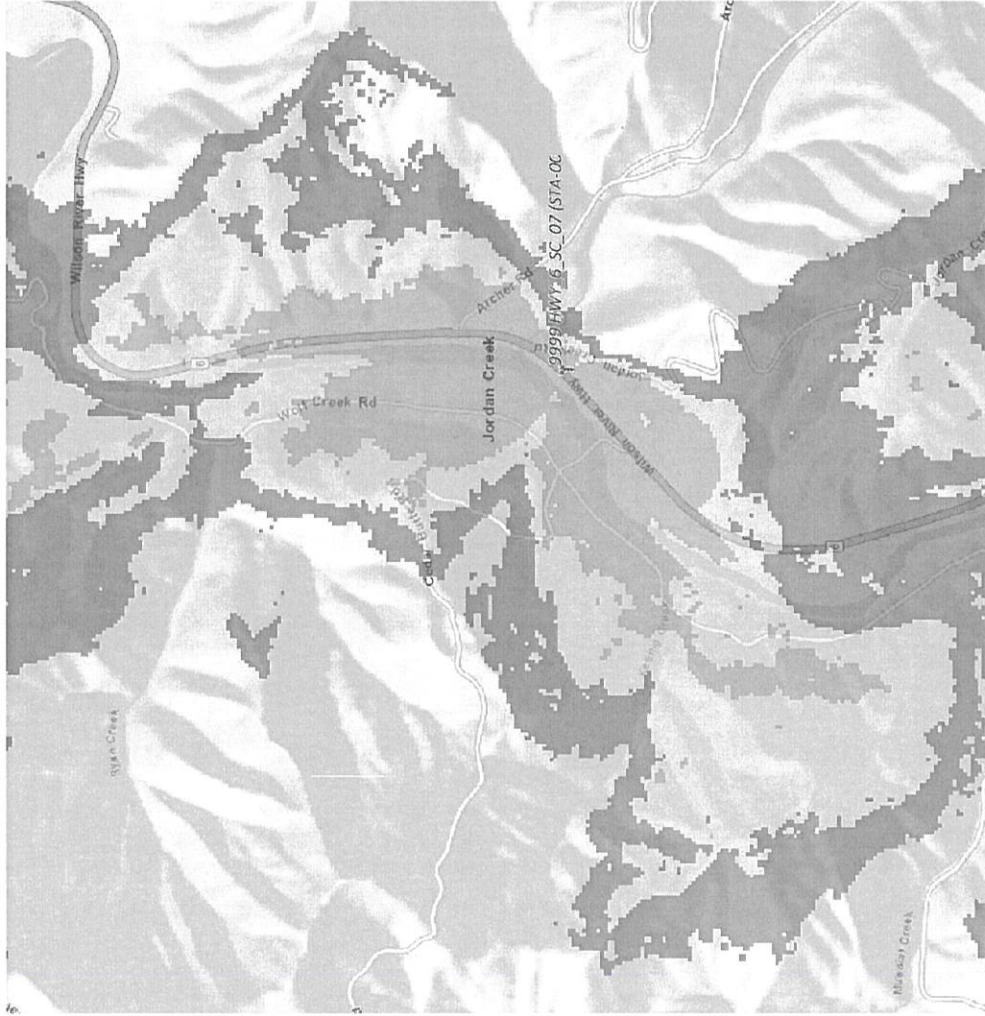

INDOOR
IN VEHICLE
OUTDOOR



Node 12

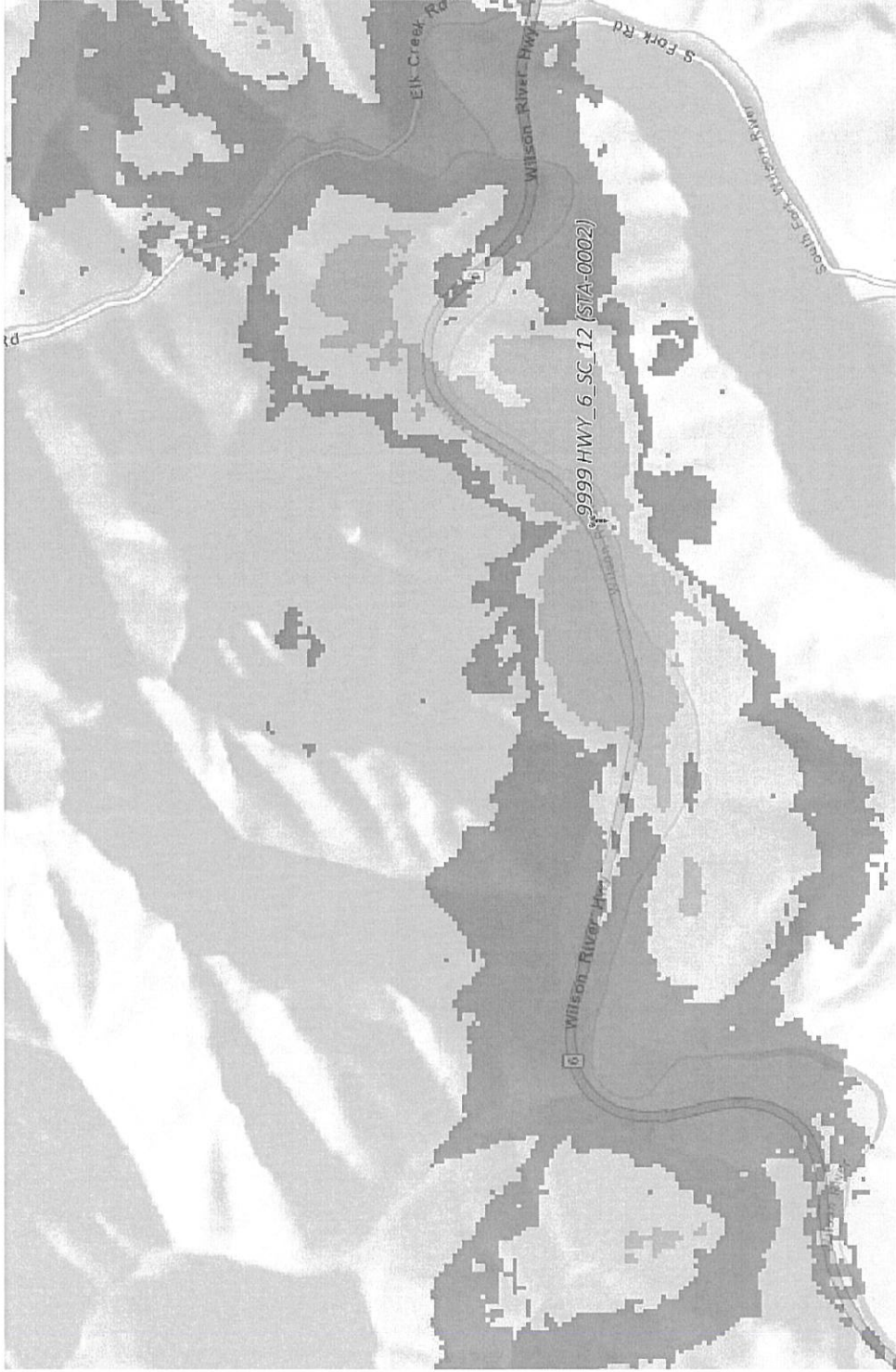

INDOOR
IN VEHICLE
OUTDOOR

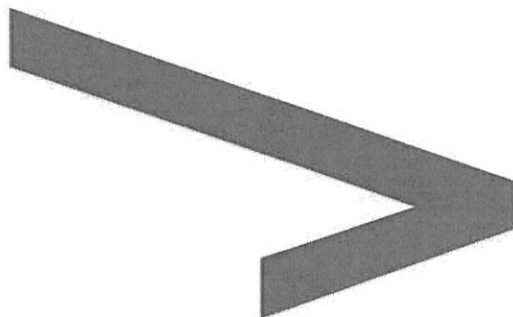

Introduction

Coverage is the need to expand wireless service into an area that either has no service or bad service. The request for service often comes from customers or emergency personnel. Expansion of service could mean improving the signal levels in a large apartment complex or new residential community. It could also mean providing new service along a newly built highway or a small community in a coverage hole.

Capacity is the need for more wireless resources. Cell sites have a limited amount of resources to handle voice calls, data connections, and data volume. When these limits are reached, user experience quickly degrades. This could mean customers may no longer be able to make/receive calls nor be able to browse the internet. It could also mean that webpages will be very slow to download. Capacity is the amount of resources a cell site has to handle customer demand. We utilize sophisticated programs that use current usage trends to forecast future capacity needs. Since it takes an average of (1-3) years to complete a cell site project, we have to start the acquisition process several years in advance to ensure the new cell site is in place before the existing cell site hits capacity limits.

Location, Location, Location. In hilly, forested terrain, wireless signals will not propagate as far as they would when compared to a flat, bare area – especially if the antennas are not installed substantially above the obstacles in the landscape. So when trying to cover a winding highway in timber country, many transmitter locations are needed close to the lane of travel to ensure a good level of wireless service to the public.

EXHIBIT C

From: [BRADLEY Robert * ODFW](#)
To: [Sarah Thompson](#); [Melissa Jenck](#)
Subject: EXTERNAL: RE: #851-24-000394-PLNG, #851-24-000395-PLNG, #851-24-000396-PLNG, #851-24-000397
Date: Friday, September 20, 2024 11:09:15 AM

[**NOTICE:** This message originated outside of Tillamook County -- **DO NOT CLICK** on links or open **attachments** unless you are sure the content is safe.]

It does not appear to be an issue for these sites, but ODFW recommends the towers not be located in, or have an impact to, the riparian setback from the Wilson River.

Robert

Robert W. Bradley
District Fish Biologist
Oregon Department of Fish and Wildlife
North Coast Watershed District
4907 Third St
Tillamook, OR 97141
503-842-2741 x18613 (w)
503-842-8385 (fax)

From: Sarah Thompson <sarah.thompson@tillamookcounty.gov>
Sent: Tuesday, September 10, 2024 4:42 PM
To: Melissa Jenck <Melissa.Jenck@tillamookcounty.gov>
Cc: Sarah Thompson <sarah.thompson@tillamookcounty.gov>
Subject: #851-24-000394-PLNG, #851-24-000395-PLNG, #851-24-000396-PLNG, #851-24-000397

Some people who received this message don't often get email from sarah.thompson@tillamookcounty.gov. [Learn why this is important](#)

Please see the links below for copies of the Notice of Application for Conditional Use Request reviews.

<https://www.tillamookcounty.gov/planning/project/851-24-000394-plng>
<https://www.tillamookcounty.gov/planning/project/851-24-000395-plng>
<https://www.tillamookcounty.gov/planning/project/851-24-000396-plng>
<https://www.tillamookcounty.gov/planning/project/851-24-000397-plng>

Thanks,

Sarah Thompson (she/her) | Office Specialist 2
TILLAMOOK COUNTY | Surveyor Department
1510-B Third Street
Tillamook, OR 97141
Phone (503) 842-3408 x3423
Sarah.thompson@tillamookcounty.gov



From: [ODOT Reg 2 Planning Manager](#)
To: [Sarah Thompson](#); [Melissa Jenck](#); [Lynn Tone](#); [Sarah Absher](#)
Subject: EXTERNAL: Application of 851-24-000394,851-24-000395,851-24-000396 & 851-24-000397 (Verizon Communication Towers)
Date: Tuesday, September 24, 2024 10:38:27 AM

[**NOTICE:** This message originated outside of Tillamook County -- **DO NOT CLICK** on links or open **attachments** unless you are sure the content is safe.]

Good Morning all,

Thank you for notifying ODOT about the proposal of a construction of new wireless communications facility (towers) along Wilson River Hwy, Tillamook County. Please include these comments in the public record and notify ODOT of the decision by sending a copy to odotr2planmgr@odot.state.or.us when available.

The properties are adjacent to State Highway, the sites will be accessed via existing approaches of HWY OR-6 (Note: the sites of towers will not have a direct access to the highway).

The proposed 10' wide easement from towers to the edge of pavement of highway is not supported and needs to be removed from Plan Set Drawings of NODE 07 page A-2.0 and NODE 03 page A-2.0 . If the applicant needs to occupy state highway right-of-way for utility work, they can contact the ODOT District 1 Main office in Astoria at 503-325-7222 for a Miscellaneous Permit.

Note:

The applicant is responsible of eliminating and removing immediately any derbies, mud, gravel etc. being placed on the highway during construction. No modifications have been proposed to the existing approaches/side roads and the proposal will not trigger any other requirements from ODOT.

Thanks,

Zdenek "Z" Vymazal, PE, PLS
Development Review Coordinator (Area 1)
ODOT – Region 2
455 Airport Rd. SE, Bldg. B
Salem, OR 97301
(971)-345-1318 Cell/Office

zdenek.g.vymazal@odot.oregon.gov

Hours: 6:30 AM to 3:00 PM Monday – Friday

From: Sarah Thompson <sarah.thompson@tillamookcounty.gov>
Sent: Tuesday, September 10, 2024 4:42 PM
To: Melissa Jenck <Melissa.Jenck@tillamookcounty.gov>
Cc: Sarah Thompson <sarah.thompson@tillamookcounty.gov>
Subject: 13434_Murakami_3

You don't often get email from sarah.thompson@tillamookcounty.gov. [Learn why this is important](#)

This message was sent from outside the organization. Treat attachments, links and requests with caution. Be conscious of the information you share if you respond.

Please see the links below for copies of the Notice of Application for Conditional Use Request reviews.

<https://www.tillamookcounty.gov/planning/project/851-24-000394-plng>

<https://www.tillamookcounty.gov/planning/project/851-24-000395-plng>

<https://www.tillamookcounty.gov/planning/project/851-24-000396-plng>

<https://www.tillamookcounty.gov/planning/project/851-24-000397-plng>

Thanks,



Sarah Thompson (she/her) | Office Specialist 2

TILLAMOOK COUNTY | Surveyor Department

1510-B Third Street

Tillamook, OR 97141

Phone (503) 842-3408 x3423

Sarah.thompson@tillamookcounty.gov

EXHIBIT D

LAND USE PLANNING NOTES▶▶▶▶



"STEWARDSHIP IN FORESTRY"

NUMBER 1 • MARCH 1991

PURPOSE: This technical bulletin has been developed jointly by the Department of Forestry and structural fire protection agencies in Oregon as technical guidance and recommended minimum standards to meet the requirements of new administrative rules, OAR 660-06-035 (fire siting standards for dwellings and structures) and OAR 66006-040 (fire safety design standards for roads) adopted by the Land Conservation and Development Commission for forest land zones (Goal 4 lands). Counties are encouraged to adopt stricter rules in forest zones where these recommendations might not adequately address a particular hazard or risk.

RULE REQUIREMENTS:

OAR 660-06-035 (Fire Siting Standards for Dwellings and Structures) requires that:

"[T]he following fire siting standards or their equivalent apply to new dwelling or structures in a forest or agriculture/forest zone:

"(1) If a water supply is available and suitable for fire protection, such as a swimming pool, pond, stream, or lake, then road access to within 15 feet of the water's edge shall be provided for pumping units. The road access shall accommodate the turnaround of fire fighting equipment during the fire season. Permanent signs shall be posted along the access route to indicate the location of the emergency water source.

"(2) Road access to the dwelling shall meet road design standards described in OAR 660-06-040.

"(3) The owners of the dwellings and structures shall: maintain a primary fuel-free break area surrounding all structures; clear and maintain a secondary fuel-free break area; and maintain adequate access to the dwelling for fire fighting

Recommended Fire Siting Standards for Dwellings and Structures *and* Fire Safety Design Standards for Roads

Published by:

Oregon Department of Forestry
Resource Planning Office
2600 State Street
Salem, OR 97310

equipment vehicles in accordance with the provisions in *Protecting Your home from Wildfire* (National Fire Protection Association)."

OAR 660-06-040 (Fire Safety Design Standards for Roads) requires that:

"[T]he governing body shall establish road design standards, except for private roads and bridges accessing only commercial forest uses, which ensure that public roads, bridges, private roads and driveways are constructed so as to provide adequate access for fire fighting equipment. Such standards shall address maximum grade, road width, turning radius, road surface, bridge design, culverts, and road access taking into consideration seasonal weather conditions. The governing body shall consult with the appropriate Rural Fire Protection District and Forest Protection District in establishing these standards."

Though there are no similar rule requirements to be met in rural residential zones in forested areas, the Department of Forestry encourages the adoption by local government of these recommended fire safety standards in these zones as well.

Turn-Around Types

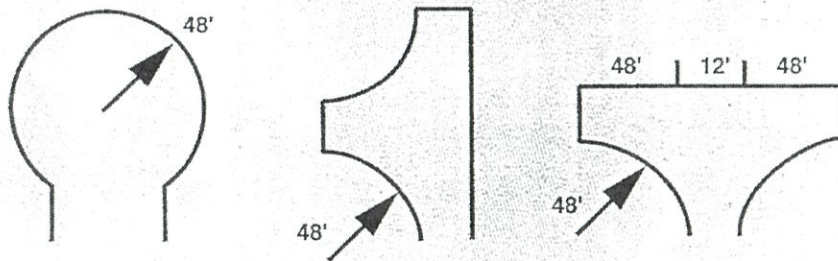

Though some of the recommendations are strictly to accommodate structural fire protection apparatus and needs, it is recommended that the standards be applied to all lands within forest zones, regardless of the presence or absence of a rural (structural) fire protection district. The standards should be applied in anticipation of structural fire protection eventually becoming present.

RECOMMENDED FIRE SITING STANDARDS FOR DWELLINGS AND STRUCTURES:

A. Water Supply Standards:

1. Access— If a water supply—such as a swimming pool, pond, stream, or lake—of 4,000 gallons or more exists within 100 feet of the driveway or road at a reasonable grade (12%) an all-weather approach to a point within 15 feet of the water's edge should be provided. The all-weather approach should provide a turn-around with a 48-foot radius of one of the types shown in the illustration below.

2. Identification— Emergency water supplies should be clearly marked along the access route with a county approved sign.

B. Fuel Break Standards:

1. Primary Safety Zone— The primary safety zone is a fire break extending a minimum of 30 feet in all directions around structures. The goal within the primary safety zone is to remove fuels that will produce flame lengths in excess of one foot. Vegetation within the primary safety zone could include green lawns and low shrubs (less than 24 inches in height). Trees should be spaced with greater than 15 feet between the crowns and pruned to remove dead and low (less than 8 feet) branches. Accumulated leaves, needles, limbs and other dead vegetation should be removed from beneath trees. Nonflammable materials (i.e., rock) instead of flammable materials (i.e., bark mulch) should be placed next to the house.

As slope increases, the primary safety zone should increase away from the house, parallel to the slope and down the slope, as shown in the table and illustration on the next page.

2. Secondary Fuel Break— The secondary fuel break is a fuel break extending a mini-

Size of Primary Safety Zone by Percent Slope

Slope	Feet of Primary Safety Zone	Feet of Additional Safety Zone Down Slope
0%	30	0
10%	30	50
20%	30	75
25%	30	100
40%	30	150

Buildings should be restricted to slopes of less than 40 percent.

EXAMPLE OF SAFETY ZONE SHAPE

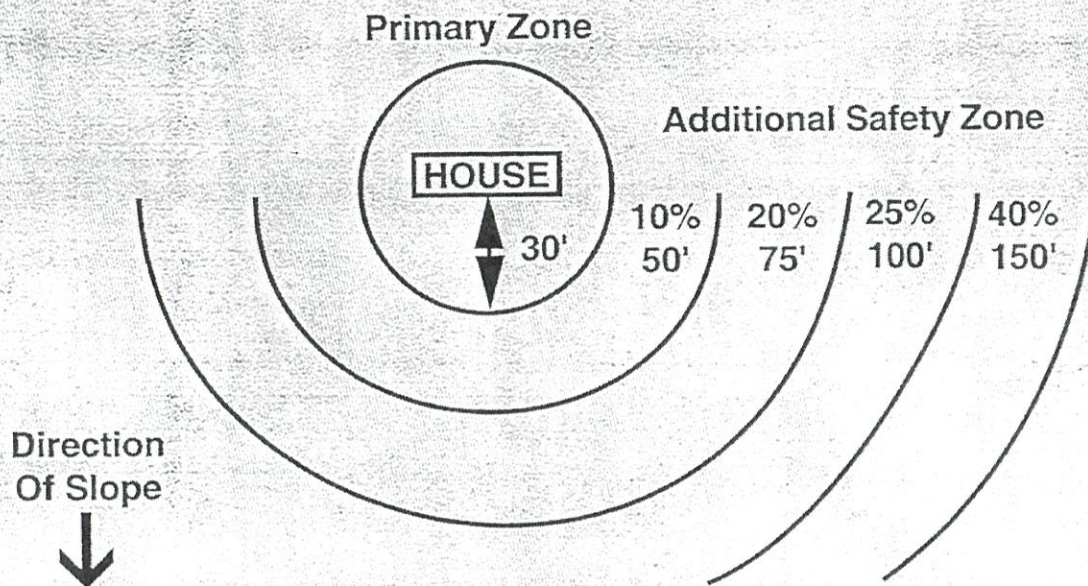

imum of **100** feet in all directions around the primary safety zone. The goal of the secondary fuel break should be to reduce fuels so that the overall intensity of any wildfire would be lessened and the likelihood of crown fires and crowning is reduced. Vegetation within the secondary fuel break should be pruned and spaced so that fire will not spread between crowns of trees. Small trees and brush growing underneath larger trees should be removed to prevent spread of fire up into the crowns of the larger trees. Dead fuels should be removed.

RECOMMENDED FIRE SAFETY DESIGN STANDARDS FOR ROADS:

A. Road Standards (public roads and private roads accessing 2 or more residences):

1. Right-of-ways— Roads should be built and maintained to provide a minimum **20** foot width of all-weather surface capable of supporting gross vehicle weights of **50,000** pounds, a minimum curve radius of **48** feet and a vertical clearance of **13'6"**.

2. Cul-de-Sacs— Cul-de-sacs should be defined as dead-end roads over **150** feet in length. Cul-de-sacs should have turn-arounds of not less than **48** feet radius at a maximum spacing of **500** feet between turn-a-rounds. All turn-a-rounds should be marked and signed as “NO PARKING.”

3. Bridges and Culverts— Bridges, culverts, and other structures in the road bed should be constructed and maintained to support gross vehicle weights of 50,000 pounds.

4. Road Grades— Road grades should not exceed an average of **8** percent, with a maxi-

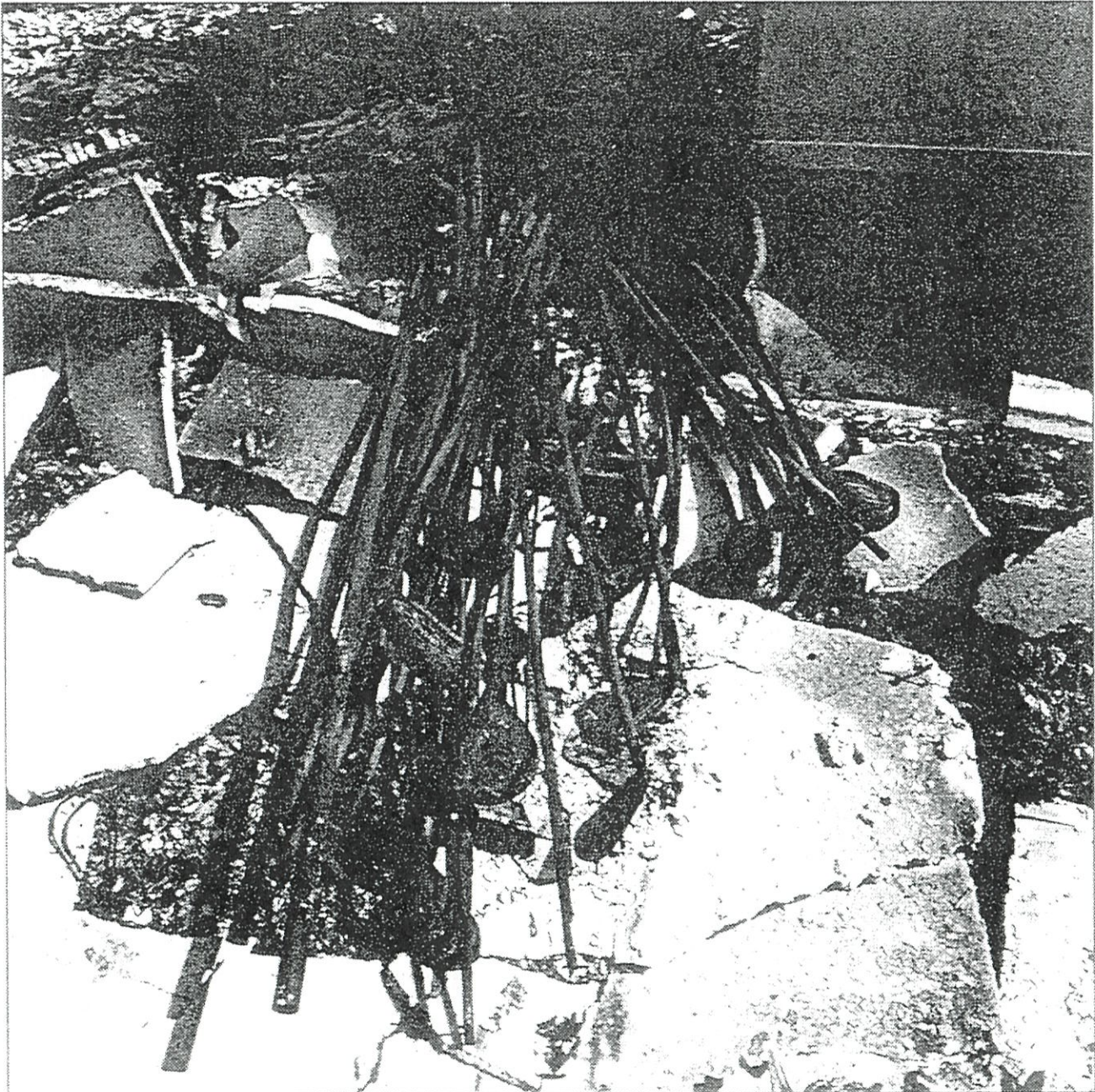

A set of burned golf clubs lay in the ruin of a home burned by the 1990 Awbrey Hall Fire. Twenty-two homes burned during this fire, which raced along the outskirts of Bend, Oregon. Most of the burned homes had insufficient fuel breaks surrounding them.

Photograph courtesy of The Bulletin, Bend

mum of **12** percent on short pitches. Variances could be granted by the fire service having responsibility for the area when topographic conditions make these standards impractical.

5. Identification— Roads should be uniquely named or numbered and visibly signed at each road intersection. Letters or numbers should be a minimum of three inches in height and constructed of reflectorized material.

B. Driveway Standards (private roads accessing a single residence):

1. Driveways— Driveways should be built and maintained to provide a minimum **12-foot** width of all-weather surface capable of supporting gross vehicle weights of **50,000** pounds, a minimum curve radius of **48** feet and a vertical clearance of **13'6"**.

2. Vehicle Passage Turnouts— Driveways in excess of **200** feet should provide **20-foot** wide by **40-foot** long passage space (turnouts) at a maximum spacing of $1/2$ the driveway length or **400** feet, whichever is less. Wherever visibility is limited, these distances should be reduced appropriately.

3. Dead-end driveways— Dead-end driveways are defined as dead-end roads over **150** feet in length serving a single residence. Dead-end driveways should have turn-a-rounds of not less than **48** feet radius.

4. Bridges and Culverts— Bridges, culverts, and other structures in the road bed should be constructed and maintained to support gross vehicle weights of 50,000 pounds.

5. Driveway Grades— Driveway grades should not exceed an average of **8** percent, with a maximum of **12** percent on short pitches. Variances could be granted by the fire service having responsibility for the area when topographic conditions make these standards impractical.

6. Identification— Driveways should be marked with the residence's address unless

the residence is visible from the roadway and the address is clearly visible on the residence. Letters or numbers should be a minimum of three inches in height and constructed of reflectorized material.

C. Certification:

1. If bridges or culverts are involved in the construction of a road or driveway, written verification of compliance with the 50,000 gross vehicle weight standard should be provided from an Oregon Registered Professional Engineer. Otherwise, written verification of compliance should be provided by the applicant.

BASIS FOR RECOMMENDATIONS:

A. Water Supply

Water is a critical tool in fire suppression. Hydrants are generally not available in forested areas. Therefore, fire suppression in forested areas is dependent upon the water carried in the responding fire equipment and water sources available for refill or that can be pumped from an engine. Water available for refilling an engine can mean the difference between saving or losing a structure, or preventing a wildfire from escaping initial attack. When a fire engine or tanker runs out of water, turn around time to a refill site may be quite lengthy. A 4,000 gallon water supply is large enough to refill a large tanker or several smaller fire engines. Requiring construction of an all weather approach to within 15 feet of 4,000 gallon or larger water sources within 100 feet or less of a driveway or road will greatly help fire protection agencies.

B. Fuel Breaks

The steeper the slope, the greater the flame length, the hotter the flame front, and the faster the rate of fire spread. This greater fire activity is primarily due to preheating of the vegetation upslope from the fire, increased draft of fresh air to the fire from below, and more flame contact with upslope fuels. On steeper slopes, failure to provide for larger safety zones downslope from a residence will make it more difficult for fire personnel to protect the structure. The

firefighter is also in a more tenuous safety position.

On the last page are two graphs showing the relationships of flame length and dozer line construction speeds to slope for two fuel types. Flame lengths increase with slope and dozer fire line construction rates decrease. Other fire fighting methods such as water attack and hand line construction are also hampered by steep slopes. Generally, hand lines are useless when flame lengths reach 4 feet; dozer lines fail with 8-foot flame lengths.

C. Road & Driveway Specifications

Fire fighting apparatus (fire engines, tankers, dozer and lowboy, etc.) are much larger and heavier than personal vehicles. These vehicles

require greater road width and clearance for passage, wider road curves for turning, and level or at most moderate road grades for maintaining vehicle engine performance and driver safety.

- The 1988 Oregon Uniform Fire Codes, Chapter 10.207 specifies that all roads shall be all weather surfaced, minimum 20 feet width, and have a vertical clearance of 13' 6".

- A filled, fully equipped 3,000 gallon tanker weighs around 40,000-45,000 pounds. Many rural fire departments utilize this size tanker as a water source for the small fire engines. A minimum road surface load limit of 50,000 pounds provides for this load plus an appropriate safety margin.

- Large, heavy vehicles have difficulty driving up and down steep road grades. Additionally, most rural fire departments are principally staffed by volunteers and most forest fire agency employees are seasonal. While these people are capable drivers, very few are professional truck drivers and they may have a more difficult time maneuvering a truck up a steep winding road than would the professional driver.

- Rural address identification is extremely important. While the local resident may be familiar with the localized road or driveway system, emergency responders generally will not. Proper signing of roads and driveways with 3" or larger reflectorized letters or numbers will assist fire fighters in locating threatened residences, especially when visibility is impaired by darkness or smoky conditions.

- It is very difficult to back up long distances in large fire apparatus, and this difficulty can be compounded if driveway grade is not level. Therefore, turnouts and turnarounds are very important.



The 1989 Dooley Mountain Fire threatened the residents of Baker City.

Photograph courtesy of the Democrat-Herald, Albany

The Relationship of Flame Length to Fuel Type and Slope: Two Situations

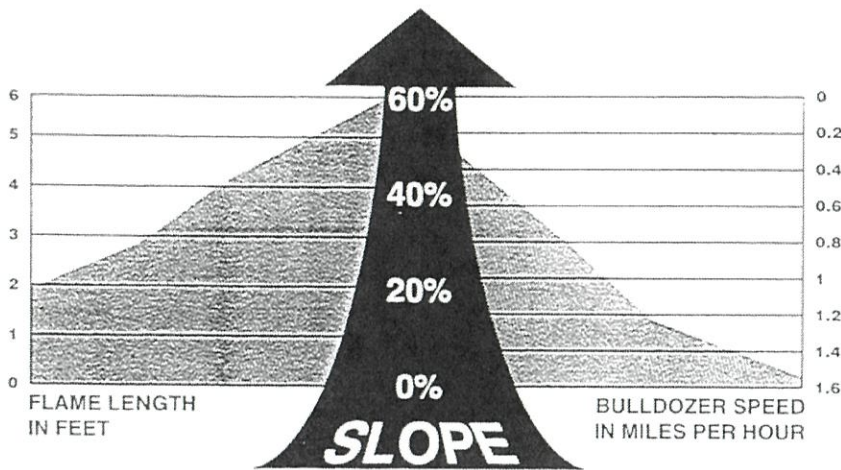

Timber with Grass Understory

These two graphs illustrate the effect of slope on flame length and bulldozer speed in two common fuel types.

In open timber with grass, flames traveling up a 20% slope can reach 3-4 feet in length.

Chaparral, on the same slope, will generate flame lengths of 6-8 feet. Hand-constructed fire lines usually fail to stop fires having 4-foot or longer flame lengths. Bulldozer-constructed fire lines usually fail to stop fires having 8-foot or longer flame lengths.

Fire lines become less effective as slope increases and as fuel loads increase.

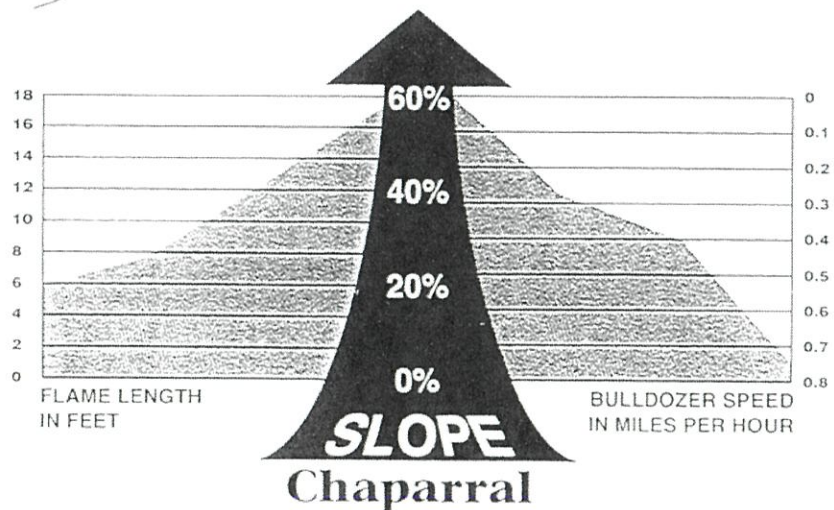

Chaparral

Information Provided By:

Oregon Department of Forestry
Resource Planning Office

Land Conservation and
Development Commission

Office of State Fire Marshal

Oregon Fire Chiefs Association

To Order Copies of This Publication
Call or Write:

Oregon Department of Forestry
Public Affairs Office
2600 State Street
Salem, Oregon 97310
503-378-2562



Oregon Department of Forestry
Resource Planning Office
2600 State Street
Salem, OR 97310

"STEWARDSHIP IN FORESTRY"